

newWORLD®

Instruction manual

NW92TDF3BL
NW92TDF3CR



You'll soon be enjoying your new Freestanding Cooker

It all begins here, with your instructions. Don't worry, there's nothing too technical coming up. Just simple, step-by-step guidance to get you up and running quickly. Sound good? Then let's get started.

Help and Guidance

We're here to help you get the most from your Freestanding Cooker. Should you require any guidance, a simple solution can often be found online at:

www.newworldassist.co.uk If you still require further assistance, call one of our experts on **0333 3052263**.

If you require any technical guidance or find that your product is not operating as intended, a simple solution can often be found in the **Troubleshooting** section of these instructions, or online at www.newworldassist.co.uk If you still require further assistance, call one of our experts on 0333 3052263.

Contents

1 Safety information

Safety information 3

2 Getting to know your Freestanding Cooker

Overview 6

Accessories 8

3 Installing your Freestanding Cooker

Installation requirements 9

Electrical connection 12

4 Using your Freestanding Cooker

Control panel 13

Oven functions 16

General oven and cooking tips 17

Practical Cooking Advice 18

Using the Gas Hob of your cooker 19

5 Care and Maintenance

Cleaning 21

Replacing oven lamps 22

Technical specification 23

6 Product support

Troubleshooting 27

Help and assistance 28

Declaration of conformance to product standards 29

Disposal 29

Safety information 1





Safety information

Important - Please read these instructions fully before installing or operating

INSTALLATION WARNINGS

IMPORTANT: Prior to Installation ensure that the local supply conditions (electricity voltage and frequency) are compatible with the requirements of your freestanding cooker.

IMPORTANT: Carefully unpack and examine the appliance for any damage. If you think there is a defect, do not use the appliance and contact NEW WORLD Product Support on 0333 305 2263. Packaging materials should be collected together and disposed of immediately as they may be harmful to children.

IMPORTANT: Keep the electrical cable (not supplied) of your freestanding cooker away from the hot areas of your appliance, do not let the cable touch the appliance. Keep the cable away from sharp edges and heated surfaces.

IMPORTANT: Ensure that the electric supply cable is not trapped or damaged during installation.

IMPORTANT: In the event that the cable connecting your freestanding cooker becomes damaged, it must be replaced by a suitably qualified person. This cable must not be replaced by an unauthorised person.

IMPORTANT: Protect your freestanding cooker against atmospheric effects. Do not expose your cooker to effects such as sun, rain, snow etc.

IMPORTANT: The materials surrounding the appliance (cabinets) must be able to withstand a minimum temperature of 100°C.

IMPORTANT: When using your oven for the first time your cooker may give off an unusual odour from the heating elements and insulation materials. To eliminate this odour run the oven at 250 degrees for 40-60 minutes with the oven empty.

WARNING: Before obtaining access to terminals, all supply circuits must be disconnected.

DURING USAGE

IMPORTANT: This appliance can be used by children aged from 8 years and above and persons with reduced physical, sensory or mental capabilities or lack of experience and knowledge if they have been given supervision or instruction concerning use of the appliance in a safe way and understand the hazards involved. Children shall not play with the appliance. Cleaning and user maintenance shall not be made by children without supervision.

WARNING: The appliance and its accessible parts become hot during use. Care should be taken to avoid touching heating elements.

WARNING: NEVER try to extinguish a cooking fire with water. Instead switch off the appliance and cover flame e.g. with a lid or a fire blanket.

CAUTION: Do not allow children in the kitchen when cooking or after, as the parts may still be hot. Many parts of the cooker will become hot and present a considerable hazard to children.

CAUTION: When the cooker is hot never touch the oven glass by hand or with tools.

CAUTION: Before starting to use your appliance, ensure curtains, paper or flammable items are kept away from your appliance. Do not keep flammable materials inside of or around your cooker.

CAUTION: Take care when closing the oven door that there is nothing obstructing it from closing as this may break the glass door.

IMPORTANT: When using the grill the oven door must be kept closed.



Safety information

Important - Please read these instructions fully before installing or operating

IMPORTANT: Make sure the oven control knobs are all in the off position when not in use

IMPORTANT: If you do not intend to use your built-in oven for a long period of time then turn off the electric supply to the oven.

GENERAL SAFETY WARNINGS

IMPORTANT: This appliance has been designed for non-professional, domestic use only. Do not use this oven for commercial use or any other application e.g room heating.

WARNING: Danger of fire: do not store flammable items on or near the cooking surfaces or inside the oven.

IMPORTANT: Do not try to lift or move this appliance by pulling on the door handle.

WARNING: Ensure that the appliance is switched off before replacing the lamp to avoid the possibility of electric shock.

IMPORTANT: Your appliance is produced in accordance with all applicable local and international standards and regulations.

IMPORTANT: Maintenance and repair work must only be performed by authorised service technicians. Installation and repair work that is carried out by unauthorised technicians is dangerous and could invalidate your guarantee.

IMPORTANT: When the door of the oven is open, do not hang or lean anything on it. You may unbalance your appliance or damage the door or door hinges.

IMPORTANT: Do not hang towels, dishcloths or clothes from the built-in oven or its handles.

CLEANING AND MAINTENANCE

IMPORTANT: Always turn the appliance off before operations such as cleaning or maintenance. You can do this by switching the freestanding cooker off using the cooker isolation switch

IMPORTANT: Do not remove the control knobs to clean the control panel.

WARNING: Do not use harsh abrasive cleaners or sharp metal scrapers to clean the oven door glass since they can scratch the surface, which may result in shattering of the glass.

TO MAINTAIN THE EFFICIENCY AND SAFETY OF YOUR APPLIANCE, WE RECOMMEND YOU ALWAYS USE OUR AUTHORISED SERVICE AGENTS AND ORIGINAL SPARE PARTS. FOR ASSISTANCE CALL NEW WORLD PRODUCT SUPPORT 0333 305 2263

Getting to know your Freestanding Cooker 2



Getting to know your Freestanding Cooker

Overview

1. Gas hob
2. 6 Button programmer
3. Grill oven temperature
4. Bottom left oven temperature
5. Grill door
6. Handle
7. Right hand oven temperature
8. Grill pan
9. Wire rack
10. Lamp
11. Wire rack
12. Oven pan

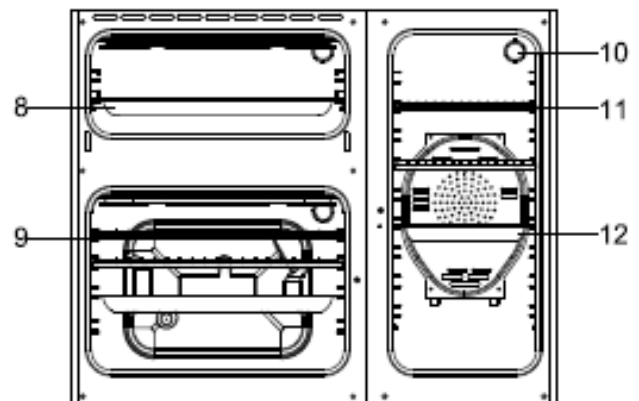
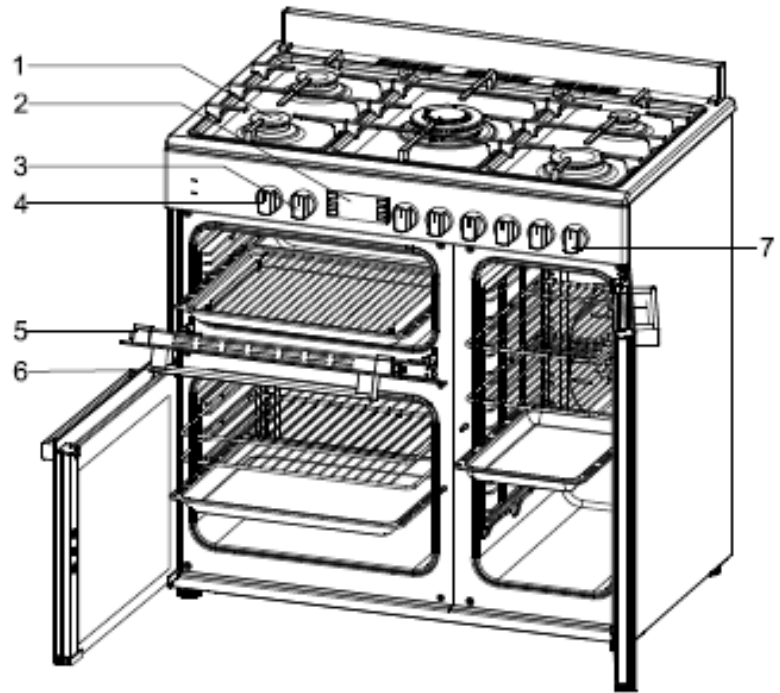

Getting to know your Freestanding Cooker

Accessories

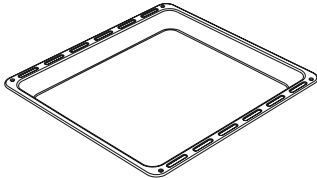

Tray / Glass tray
Used for pastry (cookie, biscuit etc.), frozen foods.

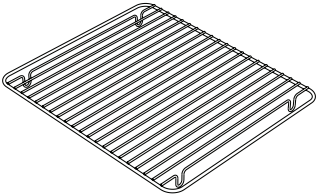

In tray wire grill
used with the grill for toasting bread or grilling other foods

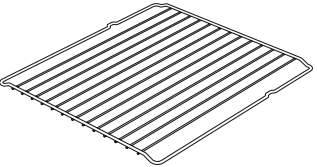

Wire grill x 2
Used for cooking food that are not suitable in baking trays - ie Pizzas

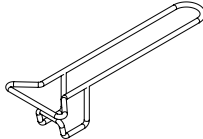

Tray handle
It is used to hold and move hot trays.

Installing your Freestanding Cooker

3



newWORLD®

Installing your Freestanding Cooker

Installation requirements

THIS COOKER MUST BE INSTALLED BY A QUALIFIED INSTALLER IN ACCORDANCE WITH LOCAL REGULATIONS



IMPORTANT: CONTACT AN AUTHORISED SERVICE AGENT FOR INSTALLATION OF YOUR FREESTANDING COOKER!

Positioning

1. Make sure that there are no combustible or flammable materials, such as curtains, in the vicinity of the installation.
2. Furniture and cabinets surrounding the cooker must be of material resistant to temperatures greater than 100°C.
3. Surrounding furniture, cabinets and extractor fans should be positioned in accordance with the diagram shown in the figure
4. There must be at least 2cm of free space between the back wall and the rear of the appliance to allow for ventilation and air circulation.
5. If fitted, the extractor fan must be at least 65cm above the hotplates. If no fan is fitted the minimum distance between the hotplates and any cabinet or other structure must be 75cm.

First Use

IMPORTANT: When using your oven for the first time your cooker may give off an unusual odour from the heating elements and insulation materials. This is normal for new cookers. To eliminate this odour run the oven at 250 degrees for 40-60 mins with the oven empty.

Unpacking

Carefully unpack and examine the appliance for any damage. If you think there is a defect, do not use the appliance and contact Product Support on 0333 305 2263.

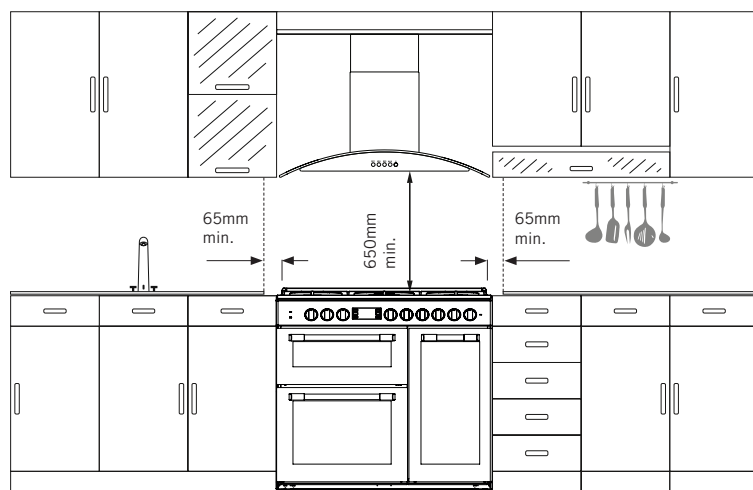

Installing your Freestanding Cooker

Levelling feet

The height and level of the appliance can be adjusted by rotating the feet located underneath the appliance at each corner. Rotate the feet to decrease or increase the height.

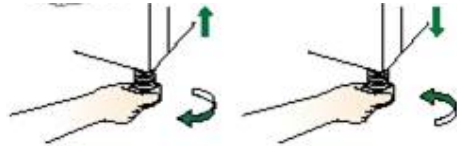
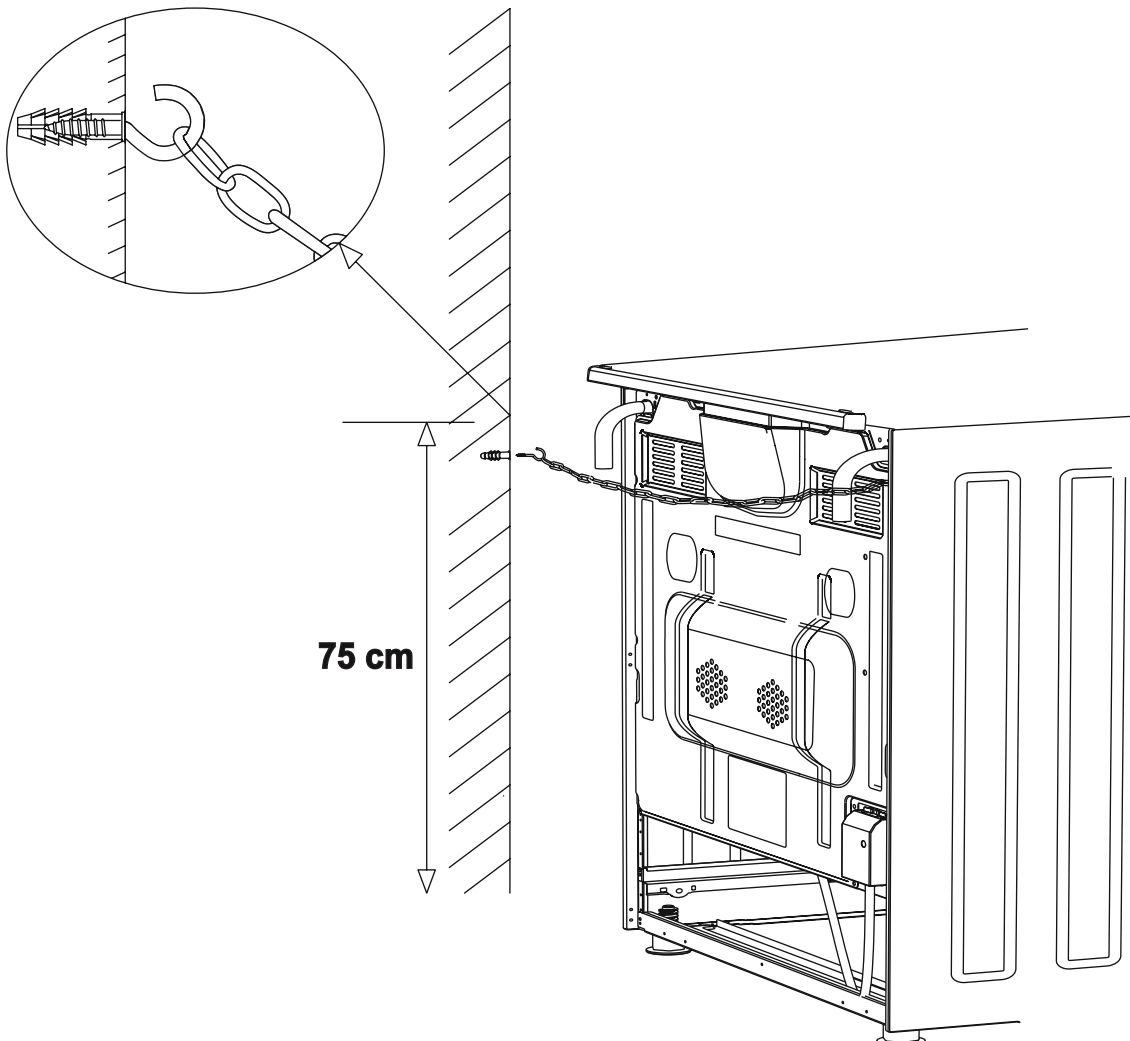

Figure 1.

Safety chain

The appliance must be secured against the possibility of tipping forward by using the supplied safety chains attached to the rear of your oven.

Fasten the stability hook provided by inserting a wall plug into the kitchen wall and then connect the safety chain to the hook via the locking mechanism.



Installing your Freestanding Cooker

Electrical connection

IMPORTANT: Electrical connections must be carried out by a suitably qualified person and in accordance with all relevant local building and installation regulations.

Fitting on a Power Supply Cable

Connecting appropriate power supply terminal board/ connector block:

- Using a screwdriver, prize open tabs of the Terminal board cover.
- Remove the wire clamp screw.
- Fasten the wires beneath the corresponding screw heads.
- Fasten cable clamp and close the cover of the terminal board.
- The ac power supply should be 220-240 V, 50/60 Hz. For electric cookers, the minimum 32A fuse, or at least 32A a distribution circuit breaker.

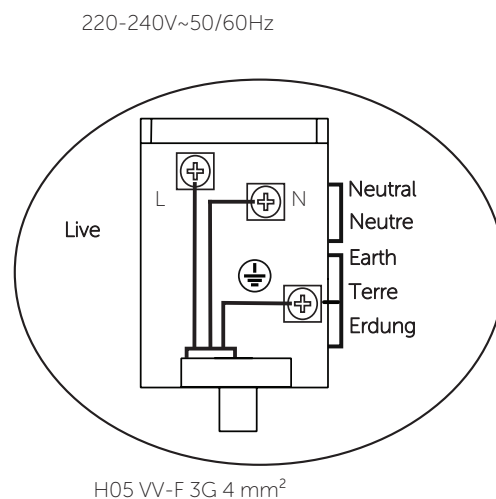

Connecting the supply cable to the mains

Install an approved circuit breaker with a minimum contact opening of 3 mm, between the appliance and the mains fuse box. The circuit breaker should be sized according to the load and should comply with current regulations (the earth wire should not be interrupted by the circuit breaker).

The supply cable should be positioned so that it does not reach a temperature of more than 50°C with respect to the room temperature, anywhere along its length. Before switching fuse ON in meter-box check:

- Earth continuity. The electrical safety of this appliance can only be guaranteed if the cooker is correctly installed and earthed, in compliance with regulations on electrical installations.
- The electrical capacity of the system and sockets will support the maximum power of the appliance, as indicated on the data plate

Using your Freestanding Cooker

Control panel

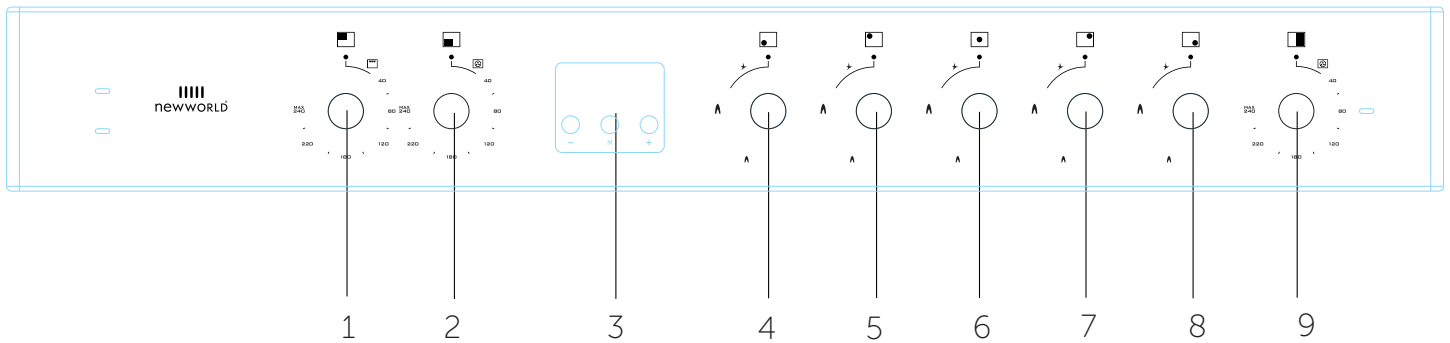

1 Thermostat

- Sets temperature for the grill

2 Function

- Sets function & temperature for cooking in left oven

3 Three button programmer

- Programs cooker and controls cooking times

4 Front Left Hob

- Adjusts temperature of hotplate.

5 Back Left Hob

- Adjusts temperature of hotplate.

6 Middle Hob

- Adjusts temperature of hotplate.

7 Back Right Hob

- Adjusts temperature of hotplate.

8 Front Right Hob

- Adjusts temperature of hotplate.

9 Function

- Sets function & temperature for cooking in right oven

Using your Freestanding Cooker

4



newworld®

Using your Freestanding Cooker

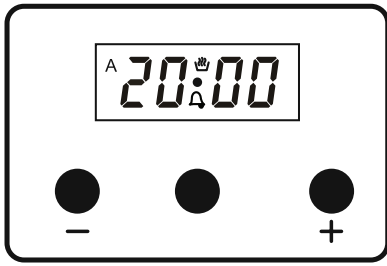

Three Button Timer

This model has an electronic timer, 24hr clock with 3 control buttons

Adjusting the digital clock

For first use of cooker, the time must be set by using the digital timer. The time must be set every time the cooker has been reset by the mains.

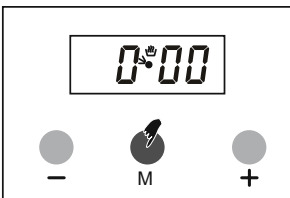

1. Press 'M' button to enter manual mode

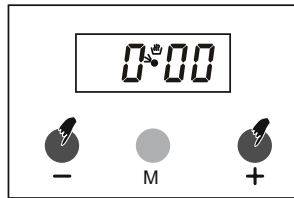

2. Press + and - buttons simultaneously to enter manual mode

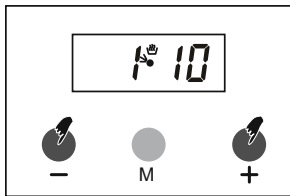

3. Press + and - buttons simultaneously

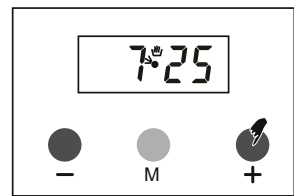

4. Use + or - buttons to adjust the time

Setting the Timer

Following the instructions below allows you to set a timer that will sound a buzzer when time has elapsed

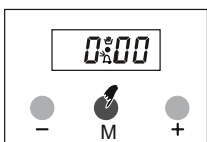

1. Press M button once - Icon will flash

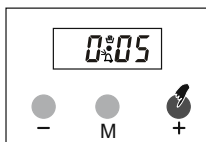

2. Set the time duration using + or - buttons

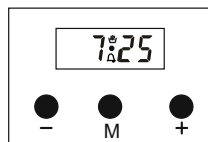

3. After a few seconds the display will return to show current time

Cancelling the Buzzer

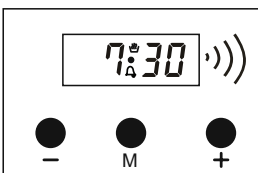

1. Buzzer will sound after set time

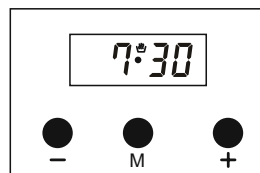

2. Press any button to cancel sound

Auto Cooking Program - Set Cooking Time

This allows you to set a timer that will turn off the oven when set cooking time is complete

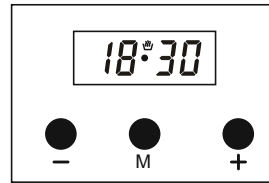

1. Current time is 18.30

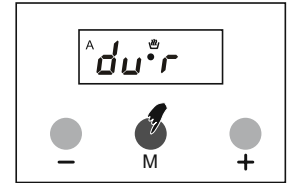

2. Press M button twice to enter Auto mode

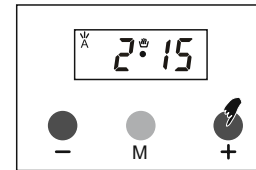

3. Adjust cooking time using + or - buttons

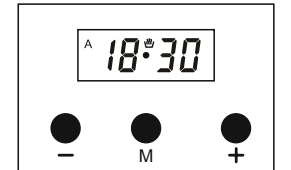

4. After a few seconds the display will return to show current time

You have now programmed your oven to cook for 2 hours 15 minutes - Remember to set function & temperature knobs now

Auto Cooking Program - Adjusted Finish Time

Your oven will turn on based on the cooking finish time set

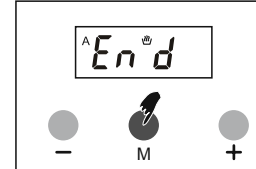

1. Press M button 3 times - the screen will display 'End' and then ready time which is 18.30 + 2 hours 15mins = 20.45

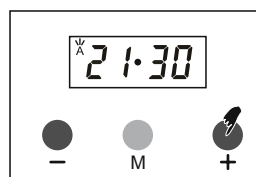

2. Set desired finish time using + or - buttons

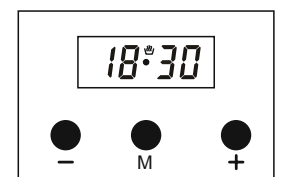

3. In a few seconds the display switches back to current time

You have now programmed your oven to have food ready for 21:30. Since you have pre-programmed as 2 hours 15 mins then your oven will start cooking at 19:15



Screen when cooking starts



Screen when cooking ends

When automatic cooking is completed, the buzzer alarm will sound.

Using your Freestanding Cooker

Oven functions



Grill



Fan Oven

Grill -The top central heating elements comes on .The extremely high and direct temperature of the grill makes it possible to brown the surface of meats and roasts while locking the juices in to keep them tender. The grill is also highly recommended for dishes that require a high temperature on the surface: beef steaks, veal, rib steak, fillets, hamburgers etc.

Fan Oven -When set to Fan mode, the element and the fan operate providing a consistent heat distributed uniformly throughout the oven. This mode is ideal for baking and cooking foods on multiple shelves at the same temperature.

Oven light -The oven light will operate on all oven functions.

Using your appliance for the first time

The first time you use your appliance, we recommend that you set the temperature setting to the highest mark. Set the function switch control knob to a cooking mode and leave the oven on for about 40-60 minutes with nothing in it and the oven door shut. Then, open the oven door and allow the oven to cool. Any odour that may be detected during this initial use is due to the evaporation of substances used to protect the oven during storage.

Using your Freestanding Cooker

General oven and cooking tips

General Oven Tips

The wire shelves should always be pushed firmly to the back of the oven.

Baking trays with food cooking on them should be placed level with the front edge of the oven's wire shelves. Other containers should be placed centrally. Keep all trays and containers away from the back of the oven, as over-browning of the food may occur.

For even browning, the maximum recommended size of a baking tray is 340 mm (13½") by 340 mm (13½").

When the oven is on, do not leave the door open for longer than necessary, otherwise the knobs may get very hot.

- Always leave 1cm gap between dishes on the same shelf. This allows the heat to circulate freely around them.
- To reduce fat splashing when you add vegetables to hot fat around a roast, dry them thoroughly or brush lightly with cooking oil.
- Where dishes may boil and spill over during cooking, place them on a baking tray.

Using your Freestanding Cooker

Practical Cooking Advice

The oven offers a wide range of alternatives which allow you to cook any type of food in the best possible way. With time you will learn to make the best use of this versatile cooking appliance and the following directions are only a guideline which may be varied according to your own personal experience.

Preheating

You should always preheat your oven before placing food in it to cook.

Once the food has been placed in the oven, the most appropriate cooking mode can then be selected.

Using the Grill

Use the grill mode  placing the food under the center of the grill (situated on the 3rd or 4th rack from the bottom) due to the central part of the top heating element being active.

Please use the grill pan set provided ensuring that there is no unwanted spillages formed inside your oven. When using this mode, we recommend you set the thermostat to the highest setting. However, this does not mean you cannot use lower temperatures, simply by adjusting the thermostat knob to the desired temperature.

When using this mode, we advise you to set the thermostat to 200°C, as it is the most efficient way to use the grill.

Baking Cakes

When baking cakes, always place them in a preheated oven. Make sure you wait until the oven has been preheated thoroughly. To prevent cake from dropping/sinking – do not open the oven door during baking.

Pastry is too dry

Increase the temperature by 10°C and reduce the cooking time.

Pastry dropped

Use less liquid or lower the temperature by 10°C.

Pastry is too dark on top

Place it on a lower rack, lower the temperature, and increase the cooking time.

Cooked well on the inside but sticky on the outside

Use less liquid, lower the temperature, and increase the cooking time.

The Pastry sticks to the pan

Grease the pan well and sprinkle it with a dusting of flour or use greaseproof paper.

Use a lower temperature setting. It is not necessary to remove the food from all the racks at the same time.

Cooking Fish and Meat

When cooking white meat, fowl and fish, use temperature setting from 180°C to 200°C.

For red meat that should be well done on the outside while tender and juicy in the inside, it is a good idea to start with a high temperature setting (200°C - 220°C) for a short time, then turn the oven down afterwards.

In general, the larger the roast, the lower the temperature setting. Place the meat on the center of the grid and place the dripping pan beneath it to catch the fat.

Make sure that the grid is inserted so that it is in the center of the oven. If you would like to increase the amount of heat from below, use the low rack heights. For savory roasts (especially duck and wild game), dress the meat with lard or bacon on the top.

Using your Freestanding Cooker

Using the burners of your cooker

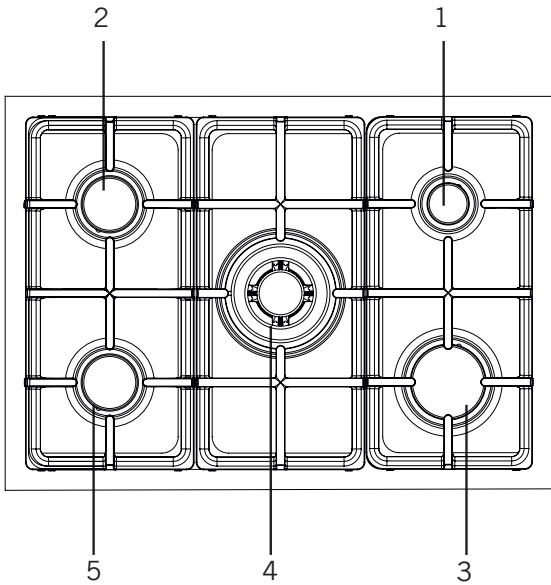

- 1. Auxiliary Burner
- 2. Normal Burner
- 3. Rapid Burner
- 4. Wok Burner
- 5. Normal Burner

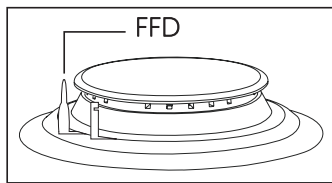

Flame failure device (FFD) - is a part of the gas burner system that ensures that the fuel supply to the gas hob is cut off automatically and immediately if for any reason the flame goes out or becomes unstable.

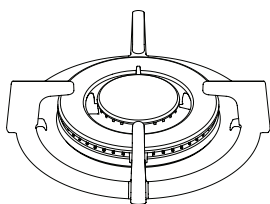

Wok Burner - Offers a double ring flame system which delivers high temperatures that are ideal for hot / fast cooking.

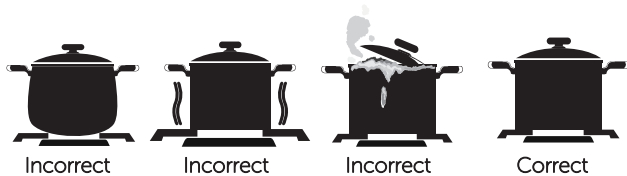

Pan Sizes

Wok burner	26-32 cm
Big burner	22-26 cm
Normal burner	18-22 cm
Small burner	12-18 cm

Care and maintenance 5



Care and maintenance

Cleaning

WARNING! Isolate the power supply to the appliance and make sure that the cooker is cool.

Before cleaning your cooker or performing maintenance, make sure that the cooking mode selection knob and the cooking temperature selection knob is set to 'OFF'. To extend the life of your cooker, it must be cleaned frequently. The inside of the cooker should preferably be cleaned immediately after use, when it is still warm (but not hot, with warm water and soap. The soap should be rinsed away and the interior dried thoroughly. Avoid using abrasive detergents, scourers, acidic cleaners such as lime scale remover, etc, as these could damage the enamel, and can result in development of rust and corrosion. If stains are particularly tough to remove, use cleaners specifically recommended to clean cookers and follow the instructions provided with the cleaner.

Never use steam cleaner for cleaning inside the cooker.

Do not clean using caustic creams, abrasive cleaning powders, thick wire wool or hard tools. Enameled parts of the cooker can be damaged if excess cleaning liquids are not immediately removed.

After cleaning the interior parts of the cooker with a soapy cloth, rinse it and then dry thoroughly with a soft cloth.

Clean the glass surfaces with special glass cleaning agents.

Never use flammable agents like acid, thinner or petrol when cleaning your appliance.

Do not clean your cooker with a steam cleaner.

Do not wash any part of your cooker in a dishwasher.

Enameled Parts:

In order to keep enameled parts as new, it is necessary to clean them frequently with mild warm soapy water and then dry with a cloth. Do not wash them while hot and never use abrasive powders or abrasive cleaning materials. Do not leave anything spilled onto enameled parts for long periods of time.

Stainless Steel:

Stainless steel parts must be cleaned frequently with mildly warm soapy water and a soft sponge and then dried with a soft cloth. Do not use abrasive powders or abrasive cleaning materials. Do not leave anything spilled onto stainless steel parts for long periods of time.

Care and maintenance

Replacing the oven lamps

- Disconnect the oven from the power supply at the fuse-box by means of the switch used to connect the appliance to the electrical mains, or unplug the appliance.
- Remove the glass cover of the lamp-holder by rotating anti-clockwise.
- Remove the lamp and replace with a lamp resistant to high temperatures (300 °C) with the following characteristics:

Voltage: 220-240V

Wattage: 25W

Type: G9

Replace the glass cover. Reconnect the appliance to the mains power supply.

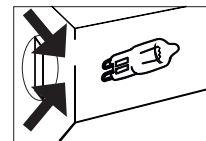
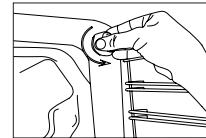

Cleaning the oven door / How to remove the oven doors

For a more thorough clean, you can remove and disassemble the oven door. Proceed as follows:

Oven door removal and assemble procedure:

- Open the door to the full extent (fig.1)
- Open the lever A completely on the left and right hinges (fig.2).
- Hold the door as shown in (fig.3).
- Gently close the door (fig.3) until left and right hinge levers A are hooked to part B of the door (fig.4).
- Withdraw the hinge hooks from their location following arrow C (fig.4).
- Rest the door on a soft surface.
- To replace the door, repeat the above steps in reverse.

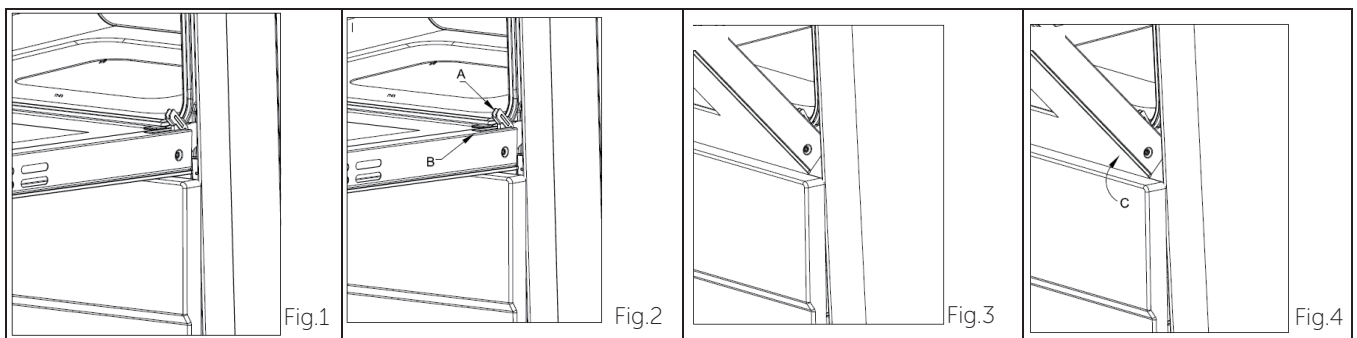

Care and maintenance

Technical specification

Model	NW92TDF3BL	NW92TDF3CR
Voltage and frequency	220-240V AC 50Hz	220-240V AC 50Hz
Top Left Oven Power	1415 W	1415 W
Bottom Left Oven Power	1840 W	1840 W
Tall Right Oven Power	1840 W	1840 W
Top Left Oven Usable Capacity	30L	30L
Bottom Left Oven Usable Capacity	60L	60L
Tall Right Oven Usable Capacity	67L	67L
Total Power	5095 W	5095 W

We apologise for any inconvenience caused by minor inconsistencies within these instructions that may occur due to product improvements and development.
All images and drawings are for illustration purposes only.

PRODUCT FICHE

Comply with Energy Label Directive Eu 2010/30/EU - Regulation No 65/2014 of ovens according to EN 60350-1 or EN 15181

Comply with EU directive 2009/125/EC - regulation No 66/2014 according to EN 60350-1 or EN 15181

Brand			
Model	NW92TDF3BL / NW92TDF3CR		
Type of oven	Free Standing	X	
	Built-in		
Mass of the appliance(M)(Net weight)kg	75,5	kg	
Number of cavities	3		
Heat source per cavity	Electrical	X	
	Gas		
	Mix		
Volume per cavity	60	l	
Energy consumption (electricity) required to heat a standardised load in a cavity of an electric heated oven during a cycle in conventional mode per cavity (electric final energy)	EC electric cavity		kWh/cycle
Energy consumption required to heat a standardised load in a cavity of an electric heated oven during a cycle in fan-forced mode per cavity (electric final energy)	EC electric cavity	0.76	kWh/cycle
Energy consumption required to heat a standardised load in a gas-fired cavity of an oven during a cycle in conventional mode per cavity (gas final energy)	EC gas cavity		MJ/cycle kWh/cycle (¹)
Energy consumption required to heat a standardised load in a gas-fired cavity of an oven during a cycle in fan-forced mode per cavity (gas final energy)	EC gas cavity		MJ/cycle kWh/cycle (¹)
Energy Efficiency Index per cavity	EEL cavity	95	
Energy Efficiency Class	A		

(¹) 1 kWh/cycle = 3,6 MJ/cycle.

PRODUCT FICHE

Comply with Energy Label Directive Eu 2010/30/EU - Regulation No 65/2014 of ovens according to EN 60350-1 or EN 15181

Comply with EU directive 2009/125/EC - regulation No 66/2014 according to EN 60350-1 or EN 15181

Brand			
Model	NW92TDF3BL / NW92TDF3CR		
Type of oven	Free Standing	X	
	Built-in		
Mass of the appliance(M)(Net weight)kg		75,5	kg
Number of cavities		3	
Heat source per cavity	Electrical	X	
	Gas		
	Mix		
Volume per cavity		67	l
Energy consumption (electricity) required to heat a standardised load in a cavity of an electric heated oven during a cycle in conventional mode per cavity (electric final energy)	EC electric cavity		kWh/cycle
Energy consumption required to heat a standardised load in a cavity of an electric heated oven during a cycle in fan-forced mode per cavity (electric final energy)	EC electric cavity	0.99	kWh/cycle
Energy consumption required to heat a standardised load in a gas-fired cavity of an oven during a cycle in conventional mode per cavity (gas final energy)	EC gas cavity		MJ/cycle kWh/cycle (¹)
Energy consumption required to heat a standardised load in a gas-fired cavity of an oven during a cycle in fan-forced mode per cavity (gas final energy)	EC gas cavity		MJ/cycle kWh/cycle (¹)
Energy Efficiency Index per cavity	EEl cavity	119,3	
Energy Efficiency Class	B		

(¹) 1 kWh/cycle = 3,6 MJ/cycle.

PRODUCT FICHE		
Information For Domestic Gas-Fired Hobs		
Comply With Eu Directive 2009/125/EC- Regulation No 66/2014 according to EN 30-2-1		
Brand		
Model		
Type Of Hob	Electrical	
	Gas	X
	Mix	
Number of gas burners		5
Energy efficiency per gas burner EE gas burner	Front Left Zone	56,0
	Rear Left Zone	56,0
	Front Right Zone	55,5
	Rear Right Zone	-
	Front Center Zone	
	Rear Center Zone	55,1
Energy Efficiency For The Gas Hob EE Gas Hob		55,6

Product support 6



Product support

Troubleshooting

If you have a problem with your appliance, check the troubleshooting table below to try and rectify your problem before calling your product support service centre.

Problem	Causes	What to do
Oven or grill not working	Digital Clock not set properly	Refer to digital timer instructions
	120 min Timer not in "Manual" position	Refer to 120 min timer instructions
	Power not turned on	Switch on electricity
	Household fuse blown	Check fuses
	Controls incorrectly set	Reset controls
	Circuit breaker tripped	Check circuit breaker
Oven light not working	Power not turned on	Switch on electricity
	Household fuse blown	Check fuses
	Circuit breaker tripped	Check circuit breaker
	Lamp blown or loose in socket	Replace or tighten globe
Oven not hot enough	Heat escaping through incorrectly sealed door	Check shelves or dishes are not preventing door closing properly, Check that door is fitted properly after door removal for cleaning
	Door seal is worn or has moved	Replace seal or refit it
Unit smoking when first used	Protective oils being removed	This is normal
Odour on first use of oven		This is normal
		Allow 2–4 hours for odour to dissipate (open all windows)
120 minute timer buzzer not audible	Timer not wound sufficiently	Turn timer knob past 15 minute mark Then turn to the required number of minutes
Oven shelf tight	Oven shelf not inserted correctly, may be upside down or back to front	Remove shelf and insert as per diagram

Note: Do not attempt to repair this cooker yourself, call our NEW WORLD Support Team to carry out any repairs on: 0333 305 2263.

Product support

Help is always at hand

Help and assistance

If you require any technical guidance or find that your Freestanding Cooker is not operating as intended, a simple solution can often be found in the **Troubleshooting** section of these instructions or online at www.newworldassist.co.uk

If you still require further assistance, call one of our experts on **0333 3052263**. To help give us give you a fast and efficient service please have the following information ready:

Model Ref.	<input type="text"/>	You can find these on the rating plate - a small information panel (usually a sticker or metal plate) on the rear of your appliance
Serial number	<input type="text"/>	
Date of purchase	<input type="text"/>	This will be shown on your receipt

Local call rates applies*

Lines open 9am-5:30pm Monday to Friday

*Calls to New World enquiry lines may attract a charge and set up fee from residential lines depending on your call plan/tariff. Mobile and other providers costs may vary, see www.bt.com/pricing for details.

For Security and training purposes, telephone calls to and from customer service centres maybe recorded and monitored. Calls from Republic of Ireland will attract international call charges.

Declaration of conformance to product standards

This appliance conforms to all relevant standards applicable to domestic appliances sold in the UK

Disposal



This appliance/fitting is marked according to the European directive 2012/19/EU on Waste Electrical and Electronic Equipment (WEEE).

By ensuring this product is disposed of correctly, you will help prevent potential negative consequences for the environment and human health, which could otherwise be caused by inappropriate waste handling of this product.

The symbol on the product, or on the documents accompanying the product, the **crossed out wheelie bin** symbol, indicates that this appliance/fitting may not be treated as household waste. Instead it shall be handed over to the applicable collection point for the recycling of electrical and electronic equipment.

Disposal must be carried out in accordance with local environmental regulations for waste disposal.

For more detailed information about treatment, recovery and recycling of this product, please contact your local authority, your household waste disposal service or the retailer where you purchased the product.



Activate your 24 month guarantee

Thank you for choosing New World. Your new product is guaranteed against faults and breakdowns for 24 months. Don't forget to register it with us today so we can provide you with our best possible after-sales service and useful updates.

www.newworldassist.co.uk

Orcall 0333 3052263

Your newworld Guarantee

This product is guaranteed for thirty six months from the date of original purchase. Any defect that arises due to faulty materials or workmanship will be repaired free of charge (or if applicable the product will be replaced or the purchase price refunded) where possible during this period by the dealer from who your purchased the unit.

The guarantee is subject to the following provisions:

- The guarantee does not cover accidental damage, misuse, cabinet parts, knobs or consumable items.
- The product must be correctly installed and operated in accordance with the instructions contained in the manual.
- It must be used solely for domestic purposes. The guarantee will be rendered invalid if the product is re-sold or has been damaged by inexpert repair.
- Specifications are subject to change without notice.
- Newworld disclaim any liability for loss or damage arising from the breakdown of the product.
- This guarantee is in addition to and does not diminish your statutory or legal rights.

Important Data Protection Information

To find out how we use your data please refer to the guarantee registration material or visit www.newworldassist.co.uk



Contact:

www.newworldassist.co.uk

Helpline: 0333 3052263