

IIIIII
newWORLD®

Instruction Manual



Induction Hob

NWI60B

Contents

1 Safety information

Safety information 4

2 Getting to know your induction hob

Ready? Let's begin 8

Product features 9

3 Installing your induction hob

General instructions 11

Electrical connection and safety 13

4 Using your induction hob

Induction zone 15

Switching the appliance on 15

Switching the appliance off 15

Using the cooking areas 16

Child lock 16

Timer function 17

Pot identification 18

Automatic cooking function 19

Error codes 19

Technical specifications 20

5 Care and Maintenance

General Cleaning 22

Cleaning the ceramic glass 22

6 Product support

Troubleshooting 24

Transport 24

Help and assistance 25

Declaration of conformance to product standards 26

Disposal 26

Safety information

1



Safety information



Important - Please read these instructions fully before installing or operating



- Carefully read all instructions before using your appliance and keep them in a convenient place for reference when necessary.
- This manual has been prepared for more than one model therefore your appliance may not have some of the features described within. For this reason, it is important to pay particular attention to any figures whilst reading the operating manual.



General safety warnings

- This appliance can be used by children aged from 8 years and above and by persons with reduced physical, sensory or mental capabilities or lack of experience and knowledge if they have been given supervision or instruction concerning use of the appliance in a safe way and understand the hazards involved. Children should not play with the appliance. Cleaning and user maintenance should not be made by children without supervision.

 **WARNING:** The appliance and its accessible parts become hot during use. Care should be taken to avoid touching heating elements. Keep children less than 8 years of age away unless they are continually supervised.

  **WARNING:** Unattended cooking on a hob with fat or oil can be dangerous and may result in fire. NEVER try to extinguish such a fire with water; switch off the appliance and cover the flame with a lid or a fire blanket.

  **WARNING:** Danger of fire: do not store items on the cooking surfaces.

  **WARNING:** If the surface is cracked, switch off the appliance to avoid the possibility of electric shock.

- For induction hobs, metallic objects such as knives, forks, spoons and lids should not be placed on the hob surface because they can get hot.
- For induction hobs, after use switch off the hob element using the control knob. Do not rely on the pan detector.
- For models which incorporate a hob lid, clean any spillages off the lid before use and allow the cooker to cool before closing the lid.
- Do not operate the appliance with an external timer or separate remote-control system.
- Do not use harsh abrasive cleaners or scourers to clean oven surfaces. They can scratch the surfaces which may result in shattering the door glass or damage to surfaces.
- Do not use steam cleaners for cleaning the appliance.
- Your appliance is produced in accordance with all applicable local and international standards and regulations.



Safety information

Important - Please read these instructions fully before installing or operating

- Maintenance and repair work should only be carried out by authorised service technicians. Installation and repair work that is carried out by unauthorised technicians may be dangerous. Do not alter or modify the specifications of the appliance in any way. Inappropriate hob guards can cause accidents.
- Before connecting your appliance, make sure that the local distribution conditions (nature of the gas and gas pressure or electricity voltage and frequency) and the specifications of the appliance are compatible. The specifications for this appliance are stated on the label.

 **CAUTION:** This appliance is designed only for cooking food and is intended for indoor domestic household use only. It should not be used for any other purpose or in any other application, such as for non-domestic use, in a commercial environment or for heating a room.

- All possible measures have been taken to ensure your safety. Since the glass may break, care should be taken while cleaning to avoid scratching. Avoid hitting or knocking the glass with accessories.
- Make sure that the supply cord is not trapped or damaged during installation. If the supply cord is damaged, it must be replaced by the manufacturer, its service agent or similarly qualified persons in order to prevent a hazard.

Installation warnings

- Do not operate the appliance before it is fully installed.
- The appliance must be installed by an authorised technician. The manufacturer is not responsible for any damage that might be caused by defective placement and installation by unauthorised people.
- When the appliance is unpacked, make sure that it has not been damaged during transportation. In the case of a defect, do not use the appliance and contact a qualified service agent immediately. The materials used for packaging (nylon, staplers, styrofoam, etc.) may be harmful to children and they should be collected and removed immediately.
- Protect your appliance against atmospheric effects. Do not expose it to effects such as sun, rain, snow, dust or excessive humidity.
- Materials around the appliance (i.e. cabinets) must be able to withstand a minimum temperature of 100°C.
- The temperature of the bottom surface of the hob may rise during operation, therefore a board must be installed underneath the product.



Safety information

Important - Please read these instructions fully before installing or operating

During use

- Do not put flammable or combustible materials in or near the appliance when it is operating.



Do not leave the cooker unattended while cooking with solid or liquid oils. They may catch fire under extreme heating conditions. Never pour water on to flames that are caused by oil, instead switch the cooker off and cover the pan with its lid or a fire blanket.

- If the product will not be used for a long period of time, turn the main control switch off.
- Always position pans over the centre of the cooking zone and turn the handles to a safe position so they cannot be knocked or grabbed.
- Make sure the appliance control knobs are always in the “0” (stop) position when it is not in use

During cleaning and maintenance

- Make sure that your appliance is turned off at the mains before carrying out any cleaning or maintenance operations.
- Do not remove the control knobs to clean the control panel.
- To maintain the efficiency and safety of your appliance, we recommend you always use original spare parts and to call our authorised service agents in case of need.

CE declaration of conformity



We declare that our products meet the applicable European Directives, Decisions and

Regulations and the requirements listed in the standards referenced.

This appliance has been designed to be used only for home cooking. Any other use (such as heating a room) is improper and dangerous.



The operating instructions apply to several models. You may notice differences between these instructions and your model.

Getting to know your induction hob

2

Getting to know your induction hob

You'll be up and running in no time

Ready? Let's begin...

Please read these instructions carefully. They contain important information which will help you get the best from your hob and ensure safe and correct installation and operation.

If you require any further assistance, our technical experts are happy to help. For full details, refer to the product support section at the end of these instructions.

Getting to know your induction hob

You'll be up and running in no time

Product features

 **Important:** Specifications for the product vary and the appearance of your appliance may differ from that shown in the figures below.

List of components



- 1. Induction zone
- 2. Control panel

Installing your induction hob

3

Installing your induction hob

Bringing it all together

WARNING: This appliance must be installed by an authorised service person or qualified technician, according to the instructions in this guide and in compliance with the current local regulations.

- Incorrect installation may cause harm and damage, for which the manufacturer accepts no responsibility and the warranty will not be valid.
- Prior to installation, ensure that the local distribution conditions (electricity voltage, and frequency and/or nature of the gas/gas pressure) and the adjustments of the appliance are compatible. The adjustment conditions for this appliance are stated on the label.

The laws, ordinances, directives and standards in force in the country of use are to be followed (safety regulations, proper recycling in accordance with the regulations, etc.).

Instructions for the installer

General instructions

- After removing the packaging material from the appliance and its accessories, ensure that the appliance is not damaged. If you suspect any damage, do not use it and contact an authorised service person or qualified technician immediately.
- Make sure that there are no flammable or combustible materials in the close vicinity, such as curtains, oil, cloth etc. which may catch fire.
- The worktop and furniture surrounding the appliance must be made of materials resistant to temperatures above 100°C.
- If a cooker hood or cupboard is to be installed above the appliance, the safety distance between cooktop and any cupboard/cooker hood should be as shown below.

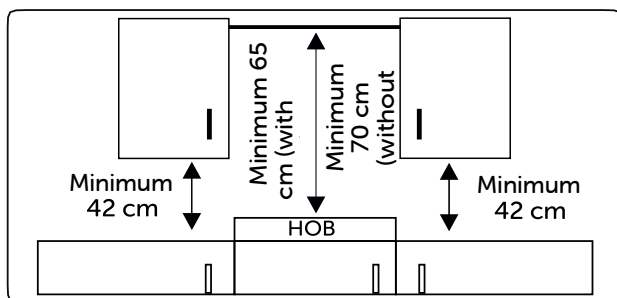

- **The appliance should not be installed directly above a dishwasher, fridge, freezer, washing machine or clothes dryer.**
 - If the base of the appliance is accessible by hand, a barrier made from a suitable material must be fitted below the base of the appliance, ensuring that there is no access to the base of the appliance.
 - If the hob is installed above an oven, the oven should have a cooling fan.
 - Make sure that the induction hob is well ventilated and the air inlet and outlet are not blocked.

Installation of the hob

The appliance is supplied with an installation kit including adhesive sealing material, fixing brackets and screws.

- Cut the aperture dimensions as indicated in the figure. Locate the aperture on the worktop so that, after the hob is installed, the following requirements are followed.

W (mm)	590	min. A (mm)	50
D (mm)	520	min. B (mm)	50
H (mm)	53	E (mm)	10
C1 (mm)	560	min. F (mm)	10
C2 (mm)	480	G (mm)	20

Installing your induction hob

Bringing it all together

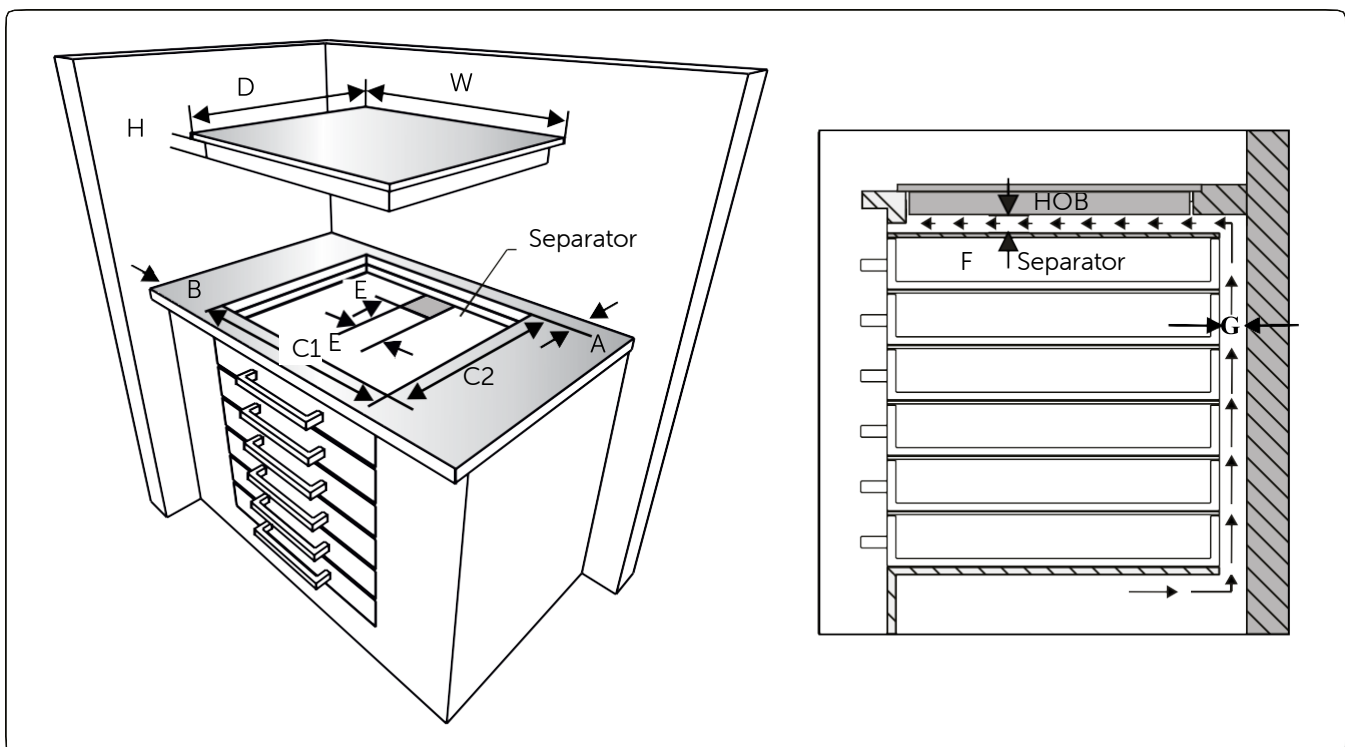
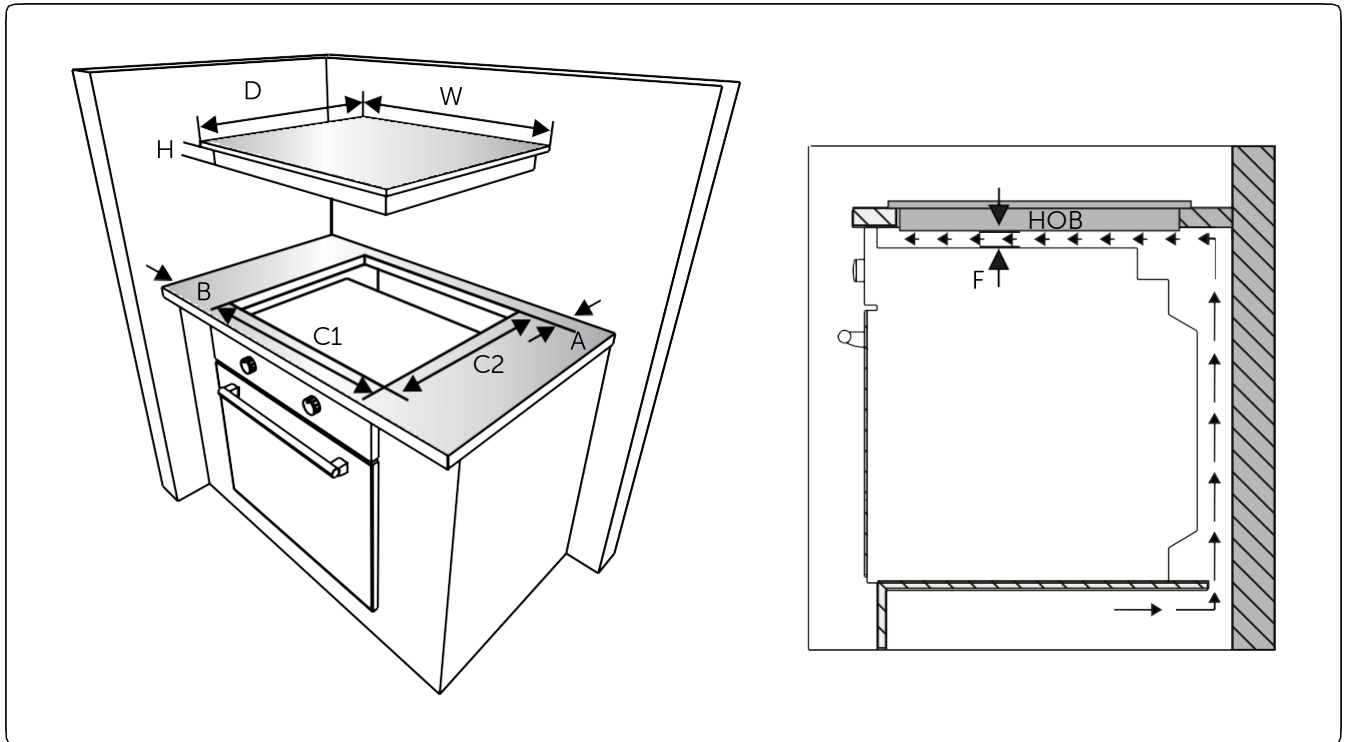

Installing your induction hob

Bringing it all together

- Apply the supplied one-sided self-adhesive sealing tape all the way around the lower edge of the cooktop. Do not stretch it.

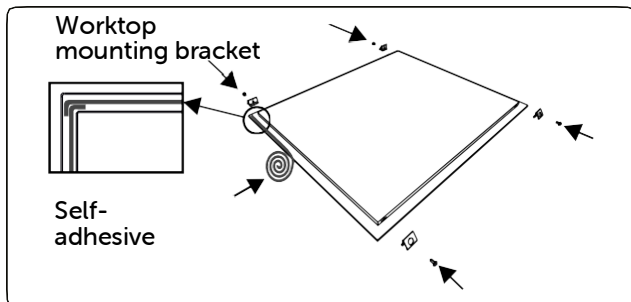

- Screw the 4 worktop mounting brackets in to the side walls of product.
- Insert the appliance into the aperture.

Electrical connection and safety

WARNING: The electrical connection of this appliance should be carried out by an authorised service person or qualified electrician, according to the instructions in this guide and in compliance with the current local regulations.

WARNING: THE APPLIANCE MUST BE EARTHED.

- Before connecting the appliance to the power supply, the voltage rating of the appliance (stamped on the appliance identification plate) must be checked for correspondence to the available mains supply voltage, and the mains electric wiring should be capable of handling the appliance's power rating (also indicated on the identification plate).
- During installation, please ensure that isolated cables are used. An incorrect connection could damage your appliance. If the mains cable is damaged and needs to be replaced this should be done by a qualified person.
- Do not use adaptors, multiple sockets and/or extension leads.
- The supply cord should be kept away from hot parts of the appliance and must not be bent or compressed. Otherwise the cord may be damaged, causing a short circuit.
- A multi-pole isolator switch (with at least 3 mm contact spacing) must be used in order to meet the safety regulations.
- The isolation switch must be easily accessible once the appliance has been installed.
- Ensure all connections are adequately tightened.
- Fix the supply cable in the cable clamp and then close the cover.
- The terminal box connection is placed on the terminal box

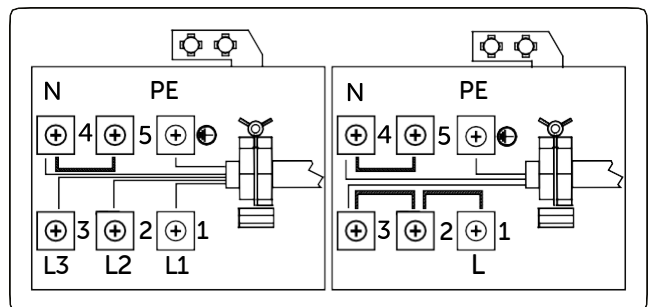

Using your induction hob

4

Using your induction hob

Simple everyday use

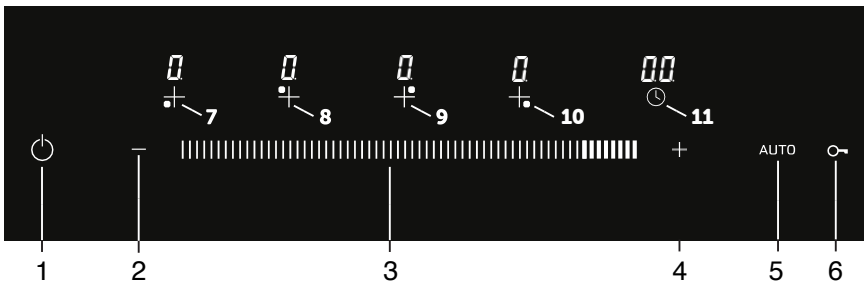







Induction zone

- | | |
|-------------------------------------|------------------------------|
| 1. On/Off function | 7. Lower left cooking area |
| 2. Timer down | 8. Upper left cooking area |
| 3. Cooking area temperature level | 9. Upper right cooking area |
| 4. Timer up | 10. Lower right cooking area |
| 5. Automatic quick cooking function | 11. Timer function |
| 6. Child lock function | |

Please note: The unit is ready to operate 1 second after it is connected to the mains power supply. All the LEDs and indicators illuminate for 1 second.



TURNING THE APPLIANCE ON

The unit is switched on by pressing the  button. The  symbol is displayed on all indicators. If the glass temperature above the hob is above 45 °C, the  and  symbols are displayed on the screen of corresponding hob, one after the other. ( for 0.5 seconds then  for 0.5 seconds)

TURNING THE APPLIANCE OFF

The unit is switched off by pressing the  button. Even if the child lock is active on the timer indicator, it is possible to switch off the appliance by pressing the  button.

WARNING: The electronics remain active for 1 minute. If there is no cooking level or selected timer in this interval, the appliance automatically switches to "Off Mode" with a beep.

Please note: If  symbol is flashing on any of the displays of the hob, the hob switches off automatically after 60 seconds of the  symbol disappearing.

RESIDUAL HEAT INDICATOR

If  symbol is flashing on the touch panel, then the relevant hob is still hot. It can be used to heat a small amount of food.

WARNING: When the power is cut off, the heat indicator does not light up and does not warn the user against the heat.





WARNING: The residual heat indicator of each cooking zone remains active until the measured glass temperature is lower than + 45°C.

Using your induction hob

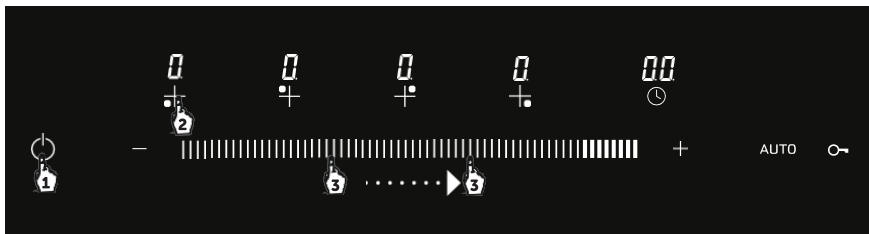
Simple everyday use





TURNING THE COOKING AREAS ON







1. The hob is switched on by pressing the  button.
2. The relevant hob is selected by pressing the  symbol once.  Symbol flashes for 5 seconds at the display of the selected hob.  symbol is displayed on all other displays.
3. By sliding your finger to the left or right on the slider, you can adjust the power level of the relevant hob from 1 to 9.



TURNING THE COOKING AREAS OFF

A hob zone may be turned off in 3 ways:



1. It can be turned off by pressing the  key.
2. After selecting the relevant hob, bring the heat level down to . The  temperature value flashes for 5 seconds.  symbol flashes if the relevant hob is still hot at the end of this period.  symbol is displayed if the relevant hob is not hot.
3. The relevant hob may be switched off by setting a timer for it. When the time has expired, the hob set by the timer automatically switches off with a beep.

CHILD LOCK FUNCTION

1. The Child lock is activated by pressing  key once.
2.  symbol is displayed on the timer display.
3. When the key lock is activated, all buttons except the ON/OFF control are deactivated.
4. To deactivate the child lock function, just press and hold the  key for 3 seconds.  symbol on the timer indicator is turned off when the time has expired.

If the child lock function is active before switching off the hob, it will be active when the hob is turned on again. When the  key is pressed,  symbol is displayed again on the timer display. Child lock must be deactivated to operate the hob again.

WARNING: Child lock is deactivated in case of a power outage.

WARNING: When the child lock is active,  symbol and remaining time are alternatively displayed on the timer display if timer is active, too ( for 2 seconds then remaining time for 2 seconds).

Using your induction hob

Simple everyday use

TIMER FUNCTION

There are two types of timer functions:

1. Independent Timer Function

It may be set when setting mode of any hob is not active. It may be used as an alarm, too. Independent timer continues to operate when any cooking area is started to be used (level > 0). Timer may be set as long as the timer selection is active (the minute on the display flashes for 5 seconds).

To set the timer;

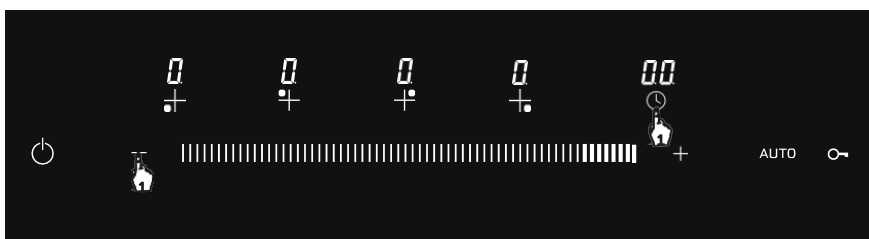

1. Timer may be set from 1 to 99 minutes by using the **-** or **+** keys when the hob is on or it may be set from 1 to 99 minutes by pressing the **🕒** symbol once and then using **-** or **+** keys when the stove is on.
2. The countdown starts directly with the final setting after the timer is set. After 5 seconds, timer setting mode period ends automatically and timer display indicates the set time value.



To change the time for independent timer;

After pressing the **🕒** symbol once, it may be reset to the desired time using **-** or **+** keys. The time can also be changed directly by the **-** or **+** keys without selecting the timer.

A buzzer sounds when the set time has expired and timer display flashes **00**. Press any key on the touch panel to end the buzzer.

WARNING: Buzzer ends automatically after 2 minutes if no key is touched.



WARNING: Turning off the hob (pressing on/off button) stops the independent timer. The timer does not resume when the stove is turned on.

Using your induction hob

Simple everyday use

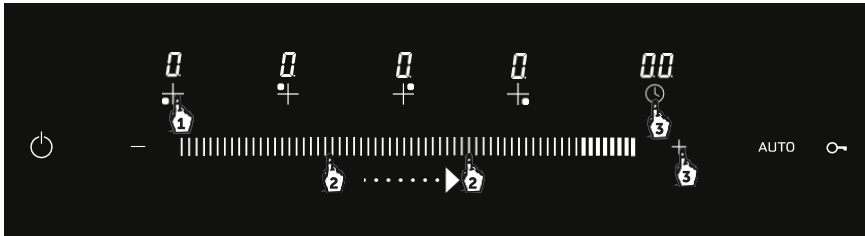
2. Cooking Area Timer Function To set the timer;



1. Select the relevant hob.
2. Set the temperature to the desired level, from 1 to 9, using the slider.
3. After pressing the  symbol once, the temperature level setting period is active (for 5 seconds). Set the desired time using the  or  keys.



The point next to the temperature level on the hob you are setting flashes.



WARNING: If more than one timer is active, the timer display indicates the lowest remaining time value after the 5-second setting period. The point next to the hob, for which the remaining time is being displayed, flashes.

A buzzer sounds and the programmed cooking area finishes the cooking function after the set time has expired.

 symbol is displayed on the touch screen and the  symbol flashes if the cooking area is still hot.

POT IDENTIFICATION / FOCUSING (No Pot Warning)

For induction cooking, power is only applied to the area covered by the base of the pot on the relevant hob zone. Cooking is stopped if there is no pot (either there is no pot, or the pot is not induction-compliant) when the cooking is started or if the pot is removed from the hob while cooking. “No pot” warning  is displayed on the touch panel for the relevant hob after 5 seconds.

The “No pot” warning lasts 55 seconds. If there is no pot on the hob when this time has expired, the cooking area is turned off automatically and the panel displays the symbol or the  symbol  if the cooking area is hot.

WARNING:  symbol flashes for 55 seconds on the relevant that gives the “no pot” warning. Setting for cooking timer also finishes when this time expires.

HIGH POWER FUNCTION (BOOST)

You may use the high-power function (boost) for faster cooking.

To use the boost function:

1. Choose the relevant hob and set the desired power level from 1 to 9.
2. Activate the boost function by pressing the boost key once. The  symbol flashes for 5 seconds on the display for the relevant hob.

The maximum period for **BOOST** function is 5 minutes. When the time has expired, the relevant hob resumes cooking with the power level initially set.

You may end the **BOOST** function using the slider for the relevant hob.

WARNING: Boost function cannot be set at the same time for the vertical hobs.

Using your induction hob

Simple everyday use

AUTOMATIC QUICK COOKING FUNCTION (AUTO)

The automatic quick cooking function **AUTO** helps you quickly cook for set times. Times are given in the table below.

Power Level	Auto Cooking Time
1	10
2	30
3	50
4	65
5	20
6	30
7	40
8	50
9	10

To use the auto cooking function:

1. Determine the relevant zone for cooking while the hob is on, and set the desired power level using the slider.
2. Press **AUTO** once while the setting mode is active and auto quick cooking will be activated for the period of the selected power level. 'A' symbol flashes for 5 seconds on the display of the relevant hob.
3. You may end the auto cooking function using the slider after selecting the relevant hob.

ERROR CODES AND RECOMMENDED SOLUTIONS

The table below provides the error codes, possible causes and recommended solutions for these codes.

Error Code	Possible Cause	What to do
F3 / F4	Induction stove coil temperature sensor error	Please contact the manufacturer
F9 / FA	IGBT temperature sensor error	Please contact the manufacturer
E1 / E2	Improper supply voltage	Please check whether the supply voltage is normal
E3	Induction stove coil temperature sensor high temperature warning	Please contact the manufacturer
E5	IGBT temperature sensor high temperature warning	Please start cooking again after the pot is cooled

Using your induction hob

Simple everyday use

Technical specifications

Model	NWI60B
Voltage and frequency	220-240V AC / 50Hz
Power consumption for small hot plate	1400W/1800W Booster (x2)
Power consumption for large hot plate	2000W/2600W Booster (x2)
Total Power	7200W
Recommended fuse size	31.3

Care and maintenance

5



Care and maintenance

Looking after your appliance

Cleaning

 **WARNING:** Switch off the appliance and allow it to cool before cleaning is to be carried out.

General instructions

- Check whether the cleaning materials are appropriate and recommended by the manufacturer before use on your appliance.
- Use cream cleaners or liquid cleaners which do not contain particles. Do not use caustic (corrosive) creams, abrasive cleaning powders, rough wire wool or hard tools as they may damage the cooker surfaces.
-  Do not use cleaners that contain particles, as they may scratch the glass, enamelled and/or painted parts of your appliance.
- Should any liquids overflow, clean them immediately to avoid parts becoming damaged.
-  Do not use steam cleaners for cleaning any part of the appliance.



Cleaning the ceramic glass

Ceramic glass can hold heavy utensils but may be broken if it is hit with a sharp object.

 **WARNING:** Ceramic Cooktops - if the surface is cracked, to avoid the possibility of an electric shock, switch off the appliance and call for service.

- Use a cream or liquid cleaner to clean the vitroc ceramic glass. Then, rinse and dry them thoroughly with a dry cloth.
-  Do not use cleaning materials meant for steel as they may damage the glass.
- Spilt sugary or sweet foods must be cleaned immediately after the glass has cooled.
- Dust on the surface must be cleaned with a wet cloth.
- Any changes in colour to the ceramic glass will not affect the structure or durability of the ceramic and is not due to a change in the material.

Colour changes to the ceramic glass may be for a number of reasons:

1. Spilt food has not been cleaned off the surface.
 2. Using incorrect dishes on the hob will erode the surface.
 3. Using the wrong cleaning materials. Cleaning the stainless steel parts (if available):
- Clean the stainless steel parts of your appliance on a regular basis.
 - Wipe the stainless steel parts with a soft cloth soaked in only water. Then, dry them thoroughly with a dry cloth.
 -  Do not clean the stainless steel parts while they are still hot from cooking.
 -  Do not leave vinegar, coffee, milk, salt, water, lemon or tomato juice on the stainless steel for a long time.

Product support

6

Product support

Help is always at hand

Troubleshooting



If you still have a problem with your appliance after checking these basic troubleshooting steps, please contact an authorised service person or qualified technician.

Problem	Possible Cause	Solution
Hob control card's display is blacked out. The hob or cooking zones cannot be switched on.	There is no power supply.	Check the household fuse for the appliance. Check whether there is a power cut by trying other electronic appliances.
The hob switches off while it is in use and an 'F' flashes on each display.	The controls are damp or an object is resting on them.	Dry the controls or remove the object.
The hob switches off while it is use.	One of the cooking zones has been on for too long.	You can use the cooking zone again by switching it back on.
The hob controls are not working and the child lock LED is on.	Child lock is active.	Switch off the child lock.
The saucepans make noise during cooking or your hob makes a clicking sound during cooking.	This is normal with induction hob cookware. This is caused by the transfer of energy from the hob to the cookware.	This is normal. There is no risk, neither to your hob nor to your cookware.
The 'U' symbol lights up in the display of one of the cooking zones.	There is no pan on the cooking zone, or the pan is unsuitable.	Use a suitable pan.
Power level 9 or 'P' is automatically reduced. If you select power level 'P' or 9 on two cooking zones, which are on the same side, at the same time.	Maximum power level for the two zones is reached	Operating both zones at power level 'P' or 9 would exceed the permitted maximum power level for the two zones.

Transport

If you need to transport the product, use the original product packaging and carry it using its original case. Follow the transport signs on the packaging. Tape all independent parts to the product to prevent damaging the product during transport.

If you do not have the original packaging, prepare a carriage box so that the appliance, especially the external surfaces of the product, is protected against external threats.

Help and assistance

If you require any technical guidance or find that your <enter product name> is not operating as intended, a simple solution can often be found in the **Troubleshooting** section of these instructions or online at www.newworldassist.co.uk

If you still require further assistance, call one of our experts on **0333 3052263**. To help give us give you a fast and efficient service please have the following information ready:

Model Ref.	<input type="text"/>	You can find these on the rating plate - a small information panel (usually a sticker or metal plate) on the rear of your appliance.
Serial number	<input type="text"/>	
Date of purchase	<input type="text"/>	This will be shown on your receipt.

Local call rates apply*

Lines open 9.00am-5:00pm Monday to Friday.

*Calls to enquiry lines may attract a charge and set up fee from residential lines depending on your call plan/tariff. Mobile and other providers costs may vary, see www.bt.com/pricing for details.

For Security and training purposes, telephone calls to and from customer service centres may be recorded and monitored. Calls from Republic of Ireland will attract international call charges.

Product support

Help is always at hand

Declaration of conformance to product standards

We declare that our products meet the applicable European Directives, Decisions and Regulations and the requirements listed in the standards referenced.

We apologise for any inconvenience caused by any minor inconsistencies in these instructions, which may occur as a result of product improvements and development.

Disposal



- The symbol on the product or on its packaging indicates that this product may not be treated as household waste. Instead it shall be handed over to the applicable collection point for the recycling of electrical and electronic equipment.
- By ensuring this product is disposed of correctly, you will help prevent potential negative consequences for the environment and human health, which could otherwise be caused by inappropriate waste handling of this product.
- For more detailed information about recycling of this product, please contact your local city office, your household waste disposal service or the shop where you purchased the product.



Activate your 12 month guarantee

Thank you for choosing New World. Your new product is guaranteed against faults and breakdowns for 12 months. Don't forget to register it with us today so we can provide you with our best possible after-sales service and useful updates.

www.newworldassist.co.uk

Or call 0333 305 2263 Your

New World Guarantee

This product is guaranteed for thirty six months from the date of original purchase. Any defect that arises due to faulty materials or workmanship will be repaired free of charge (or if applicable the product will be replaced or the purchase price refunded where possible during this period by the dealer from who your purchased the unit.

The guarantee is subject to the following provisions:

- The guarantee does not cover accidental damage, misuse, cabinet parts, knobs or consumable items.
- The product must be correctly installed and operated in accordance with the instructions contained in the manual.
- It must be used solely for domestic purposes. The guarantee will be rendered invalid if the product is re-sold or has been damaged by inexpert repair.
- Specifications are subject to change without notice.
- New World disclaim any liability for loss or damage arising from the breakdown of the product.
- This guarantee is in addition to and does not diminish your statutory or legal rights.

Important Data Protection Information

To find out how we use your data please refer to the guarantee registration material or visit www.newworldassist.co.uk



Contact:

www.newworldassist.co.uk

Helpline: 0333 3052263