

|||||

newWORLD[®]
Gas Twin Cavity
Freestanding Oven

NWMID53GW
NWMID53GB
NWMID53GS



USER MANUAL



You'll soon be enjoying your new Freestanding Gas
Cooker

It all begins here, with your instructions. Don't worry,
there's nothing too technical coming up. Just
simple, step-by-step guidance to get you up and
running quickly. Sound good? Then let's get started.

"THIS APPLIANCE SHALL BE INSTALLED IN ACCORDANCE WITH
THE REGULATIONS ENFORCE AND ONLY USED IN A WELL
VENTILATED SPACE. READ THE INSTRUCTIONS BEFORE INSTALLING
OR USING THIS APPLIANCE"

Contents

Important warnings.....	4
Electrical connection.....	16
Installation	17
Chain lashing instructions	20
Introduction of the appliance.....	27
Accessories	28
Technical features of your oven.....	29
Control panel	31
Using oven section.....	32
Using the grill	33
Using the hob.....	34
Pot recommendation	35
Cooking time table	36
Maintenance and cleaning.....	37
Cleaning and maintenance of the oven's door.....	38
Rack positions	39
Changing the oven lamp	40
Using the grill deflector sheet.....	41
Troubleshooting.....	42
Handling rules	44
Recommendations for energy saving.....	44
Help and Assistance.....	45
Environmentally-friendly disposal.....	46
Declaration of conformance	46
Guarantee	47



IMPORTANT WARNINGS

1. Installation and repair should always be performed by “**AUTHORISED SERVICE**”. Manufacturer shall not be held responsible for operations performed by unauthorised persons.
2. Please read the operating instructions carefully.
3. The oven should be used according to operating instructions.
4. Keep children below the age of 8 and pets away when operating.
5. **WARNING: The accessible parts may be hot while using the grill. Keep away from children.**
6. **WARNING: Fire hazard; do not store the materials on the cooking surface.**
7. **WARNING: The appliance and its accessible parts are hot during operation.**
8. Setting conditions of this device are specified on the label. (Or on the data plate)
9. The accessible parts may be hot when the grill is used. Small children should be kept away.
10. **WARNING: This appliance is intended for cooking. It should not be used for other purposes like heating a room.**
11. To clean the appliance, do not use steam cleaners.
12. Ensure that the oven door is completely closed after putting food inside the oven.



13. NEVER try to put out the fire with water. Only shut down the device circuit and then cover the flame with a cover or a fire blanket.

14. Children under 8 years of age should be kept away, if they cannot be monitored continuously.

15. Touching the heating elements should be avoided.

16. CAUTION: Cooking process shall be supervised. Cooking process shall always be supervised.

17. This device can be used by children over 8 years of age, people with physical, hearing or mental challenges or people with lack of experience or knowledge; as long as control is ensured or information is provided regarding the dangers.

18. This device has been designed for household use only.

19. Children must not play with the appliance. Cleaning or user maintenance of the appliance shall not be performed by children unless they are older than 8 years and supervised by adults.

20. Keep the appliance and its power cord away from children less than 8 years old.

21. Put curtains, tulle, paper or any flammable (ignitable) material away from the appliance before starting to use the appliance. Do not put ignitable or flammable materials on or in the appliance.

22. Keep the ventilation channels open.

23. The appliance is not suitable for use with an external timer or a separate remote control system.

24. Do not heat closed cans and glass jars. The pressure may lead jars to explode.

25. Oven handle is not a towel drier. Do not hang towels, etc. on the oven handle.

26. Do not place the oven trays, plates or aluminium foils directly on the oven base. The accumulated heat may damage the base of the oven.

27. While placing food to or removing food from the oven, etc., always use heat resistant oven gloves.

28. Do not use the product in states like medicated and/or under influence of alcohol which may affect your ability of judgement.

29. Be careful when using alcohol in your foods. Alcohol will evaporate at high temperatures and may catch fire to cause a fire if it comes in contact with hot surfaces.

30. After each use, check if the unit is turned off.

31. If the appliance is faulty or has a visible damage, do not operate the appliance.

32. Do not touch the plug with wet hands. Do not pull the cord to plug off, always hold the plug.

33. Do not use the appliance with its front door glass removed or broken.

34. Place the baking paper together with the food into a pre-heated oven by putting it inside a cooker or on an oven accessory (tray, wire grill etc.).



35. Do not put objects that children may reach on the appliance.

36. It is important to place the wire grill and tray properly on the wire racks and/or correctly place the tray on the rack. Place the grill or tray between two rails and make sure it is balanced before putting food on it.

37. Against the risk of touching the oven heater elements, remove excess parts of the baking paper that hang over from the accessory or container.

38. Never use it at higher oven temperatures than the maximum usage temperature indicated on your baking paper. Do not place the baking paper on the base of the oven.

39. When the door is open, do not place any heavy object on the door or allow children to sit on it. You may cause the oven to overturn or the door hinges to be damaged.

40. The packaging materials are dangerous for children. Keep packaging materials away from the reach of children.

41. Do not use abrasive cleaners or sharp metal scrapers to clean the glass as the scratches that may occur on the surface of the door glass may cause the glass to break.

42. Do not place the appliance on a surface covered with carpets. Electric parts gets overheated since there will be no ventilation from below. This will cause failure of the appliance.

■ ■ ■ ■

43. Do not hit glass surfaces of vitro-ceramic cookers with a hard metal, resistance can get damaged. It may cause an electric shock.

44. User should not handle the oven by himself.

45. Use shall be careful when cleaning gas burners. It may cause personal injuries.

46. Food can spill when foot of oven is dismantled or gets broken, be careful. It may cause personal injuries.

47. During usage, the internal and external surfaces of the oven get hot. As you open the oven door, step back to avoid the hot vapour coming out from the interior. There is risk of burning.

48. Upper cover of the oven can be closed for a reason, than cookware can trip over. Step back to avoid the hot food coming on you. There is risk of burning.

49. Do not place heavy objects when oven door is open, risk of toppling.

50. User should not dislocate the resistance during cleaning. It may cause an electric shock.

51. Do not remove ignition switches from the appliance. Otherwise, live electric cables can be accessed. It may cause an electric shock.

52. Oven supply can be disconnected during any construction work at home. After completing the work, re-connecting the oven shall be done by authorised service.

53. Do not place metal utensils such as knife, fork, spoon on the surface of the appliance, since they will get hot.



54. To prevent overheating, the appliance should not be installed behind of a decorative cover.

55. Turn off the appliance before removing the safeguards. After cleaning, install the safeguards according to instructions.

56. Cable fixing point shall be protected.

57. WARNING: Don't use oven and grill burners at same time.

58. Please don't cook the food directly on the tray / grid. Please put the food into or on appropriate tools before putting them in the oven.

59. Hot surface, leave for cooling before closing the cover.



Electrical Safety

1. Plug the appliance in a grounded socket protected by a fuse conforming to the values specified in the technical specifications chart.
2. Have an authorised electrician set grounding equipment. Our company shall not be responsible for the damages that shall be incurred due to using the product without grounding according to local regulations.
3. The circuit breaker switches of the oven shall be placed so that end user can reach them when the oven is installed.
4. The power supply cord (the cord with plug) shall not contact the hot parts of the appliance.
5. If the power supply cord (the cord with plug) is damaged, this cord shall be replaced by the manufacturer or its service agent or an equally qualified personnel to prevent a hazardous situation.
6. Never wash the product by spraying or pouring water on it! There is a risk of electrocution.
7. **WARNING: To avoid electric shock, ensure that the device circuit is open before changing the lamp.**
8. **WARNING: Cut off all supply circuit connections before accessing the terminals.**
9. **WARNING: If the surface is cracked, turn off the appliance to avoid risk of electric shock.**
10. Do not use cut or damaged cords or extension cords other than the original cord.

11. Make sure that there is no liquid or humidity in the outlet where the product plug is installed.

12. The rear surface of the oven also heats up when the oven is operated. Electrical connections shall not touch the rear surface, otherwise the connections may be damaged.

13. Do not tighten the connecting cables to the oven door and do not run them over hot surfaces. If the cord melts, this may cause the oven to short circuit and even a fire.

14. Unplug the unit during installation, maintenance, cleaning and repair.

15. If the power supply cable is damaged, it must be replaced by its manufacturer or authorised technical service or any other personnel qualified at the same level, in order to avoid any dangerous situation.

16. Make sure the plug is inserted firmly into wall socket to avoid sparks.

17. Do not use steam cleaners for cleaning the appliance, otherwise electric shock may occur.

18. An omnipolar switch capable to disconnect power supply is required for installation. Disconnection from power supply shall be provided with a switch or an integrated fuse installed on fixed power supply according to building code.

19. Appliance is equipped with a **type “Y”** cord cable.

20. Fixed connections shall be connected to a power supply enabling omnipolar disconnection. For appliances with over voltage category below III, disconnection device shall be connected to fixed power supply according to wiring code.

Gas Safety

1. This appliance is not connected to burning products evacuation apparatus. This appliance must be connected and installed according to the installation regulations in force. Conditions regarding ventilation must be considered.

2. When a gas cooking appliance is used; humidity, heat and burning products are generated in the room. First of all, make sure the kitchen is well ventilated when operating the appliance and maintain natural ventilation openings or install a mechanical ventilation equipment.

3. After using the appliance heavily for an extended period of time, additional ventilation may be required. For example open a window or adjust a higher speed for mechanical ventilation, if any.

4. This appliance must be used only in well ventilated locations in accordance with the regulations in force. Please read the manual before installing or using this product.

5. Before positioning the appliance, make sure local network conditions (gas type and gas pressure) meets appliance requirements.



6. The mechanism cannot be run for longer than 15 seconds. If the burner is not on after 15 seconds, stop the mechanism and wait for at least one minute before trying to ignite the burner again.

7. All kinds of operations to be performed on gas installation must be performed by authorised and competent people.

8. This appliance is adjusted for natural gas (NG). If you have to use your product with a different gas type, you have to apply to authorised service for the conversion.

9. For proper operation, hood, gas pipe and clamp should be replaced periodically according to manufacturer recommendations and when required.

10. Gas should burn well in gas products. Well burning gas can be understood from blue flame and continuous burning. If gas does not burn sufficiently, carbon monoxide (CO) can be generated. Carbon monoxide is a colourless, odourless and very toxic gas; even small amounts have lethal effect.

11. Ask your local gas supplies about the phone numbers for emergencies related to gas and the measures to be taken upon gas odour is detected.



What To Do When Gas Odour Is Detected

1. Do not use naked flame, and do not smoke.
2. Do not operate any electrical switch.

(For example: lamp switch or doorbell)

3. Do not use telephone or mobile phone.
4. Open the doors and windows.
5. Close all valves on the appliances that utilize gas and the gas counters.
6. Call fire brigade from a telephone outside the home.
7. Check all hoses and their connections against leaks. If you still smell gas, leave the house and warn your neighbours.
8. Do not enter into the house until authorities clarify it is safe.



Intended Use

- 1.** This product is designed for home use. Commercial use of the appliance is not permitted.
- 2.** This appliance may only be used for cooking purposes. It shall not be used for other purposes like heating a room.
- 3.** This appliance shall not be used to heat plates under the grill, drying clothes or towels by hanging them on the handle or for heating purposes.
- 4.** The manufacturer assumes no responsibility for any damage due to misuse or mishandling.
- 5.** Oven part of the unit may be used for thawing, roasting, frying and grilling food.
- 6.** Operational life of the product you have purchased is 10 years. This is the period for which the spare parts required for the operation of this product as defined is provided by the manufacturer.



Electrical Connection

Provision for Ventilation

The appliance housing used must provide adequate ventilation. For built-in installation, a minimum ventilation space of 45mm must exist between the rear of the appliance and the back of the housing or an adjacent wall.

If a tall housing is to be installed flush with the ceiling, a 20cm² ventilation cut-out must be provided at the top of the housing.

Electrical Connection

This appliance must be installed by a qualified electrician to comply with the relevant Institution of Engineering and Technology (I.E.T.) regulations and also the local electricity supply company requirements. This appliance must not be connected to an ordinary domestic power point.

This product comes fitted with a BS plug and cord.

Ensure the cable route avoids the risk of trapping or touching hot surfaces.

Installation

Dear Installer

Before you start your installation, please complete the details below.

Installer's Name
Installer's Company
Installer's Telephone Number
Appliance Serial Number

Should your customer have a problem relating to your installation they will be able to contact you easily.

You must be aware of the following safety requirements & regulations:

Before installing, make sure that the local distribution conditions (nature of the gas and gas pressure) and the adjustment of the appliance are compatible.

This appliance must be installed in accordance with the regulations in force and only in a well-ventilated space. Read the instructions before installing or using this appliance.

The regulations and standards are as follows:

In the UK:

In your own interest and that of safety, it is law that all gas appliances be installed by competent persons. CORGI registered installers undertake to work to safe and satisfactory standards. Failure to install the appliance correctly could invalidate any warranty or liability claims and lead to prosecution.



This appliance should not be installed in a boat or caravan.

The hob must be installed in accordance with:

- All relevant British Standards / Codes of Practice, in particular BS 5440 Part 2
- For Natural Gas – BS 6172 and BS 6891
- For LP Gas – BS 5482-1 (when the installation is in a permanent dwelling)
- The Gas Safety (Installation and Use) regulations
- The relevant Building / IET regulations

Provision of Ventilation

This appliance is not connected to a combustion products evacuation device. Particular attention shall be given to the relevant requirements regarding ventilation.

In the UK:

The room containing the hob should have an air supply in accordance with BS 5440 Part 2. All rooms require an openable window or equivalent, while some rooms require a permanent vent in addition to the openable window. The hob should not be installed in a bed sitting room with volume less than 20m^3 . If it is installed in a room of volume less than 5m^3 an air vent of effective area 100cm^2 is required; if it is installed in a room of volume between 5m^3 and 10m^3 , an air vent of effective area 50cm^2 is required; while if the volume exceeds 11m^3 , no air vent is required.

If there are other fuel burning appliances in the same room, BS 5440 Part 2 should be consulted to determine the requisite air vent requirements.



INSTALLATION OF YOUR OVEN

Check if the electrical installation is proper to bring the appliance in operating condition. If electricity installation is not suitable, call an electrician and plumber to arrange the utilities as necessary. Manufacturer shall not be held responsible for damages caused by operations performed by unauthorized persons.

WARNING: It is customer's responsibility to prepare the location the product shall be placed on and also to have the electrical installation prepared.

WARNING: The rules in local standards about electrical installations shall be followed during product installation.

WARNING: Check for any damage on the appliance before installing it. Do not have the product installed if it is damaged. Damaged products cause a risk for your safety.

Right Place for Installation and Important Warnings

Appliance feet should not stay on soft surfaces such as carpets. The kitchen floor shall be durable to carry the unit weight and any other kitchenware that may be used on the oven.

Appliance should installed with a minimum clearance of 400mm from the upper side of hob surfaces to the under side of an over head cupboard and 6.5mm from the side surfaces of the kitchen furniture.

The appliance is suitable for use on both side walls, without any support, or without being installed in a cabinet. If a hood or aspirator will be installed above the cooker, follow the instructions of the manufacturer for height of mounting. (min. 650 mm)

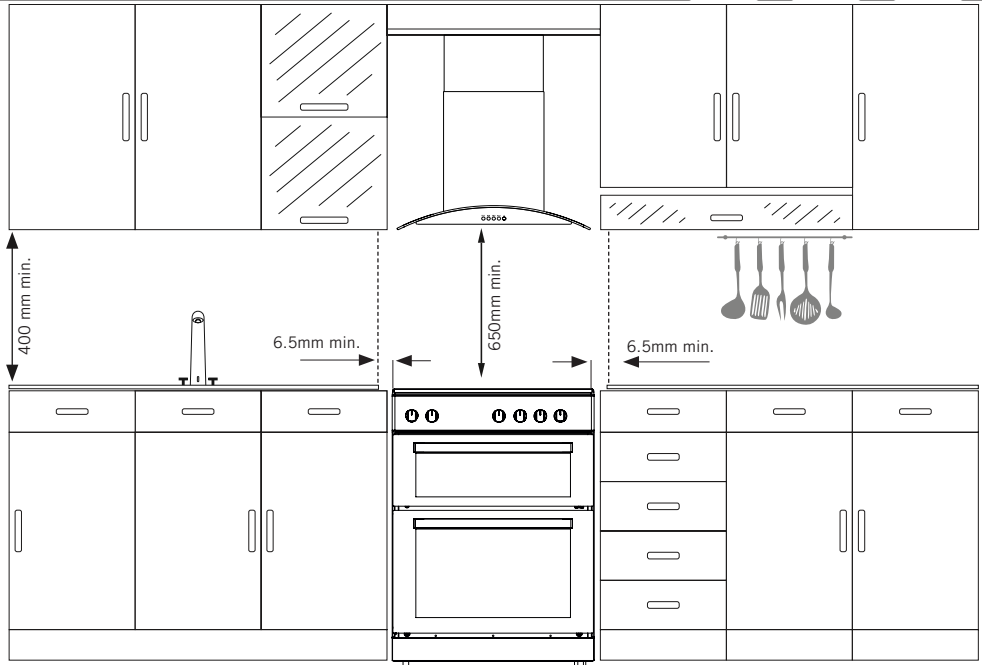

WARNING: The kitchen furniture near the appliance must be heat resistant.

WARNING: Do not install the appliance beside refrigerators or coolers. Heat radiated by the appliance increases the energy consumption of cooling devices.

WARNING: Do not use the door and/or handle to carry or move the appliance.

Chain Lashing Illustration

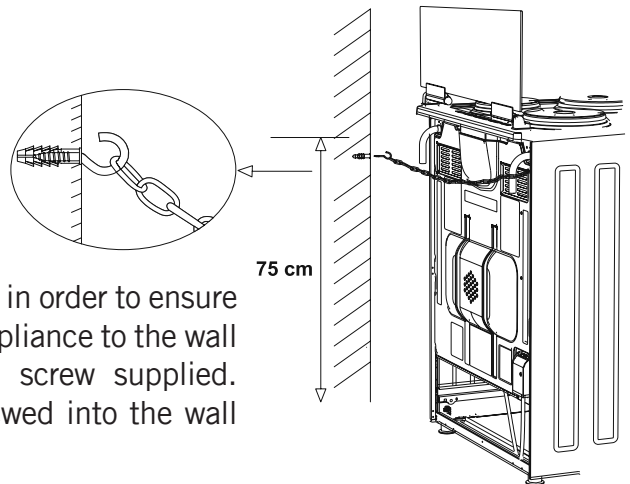

Before using the appliance, in order to ensure safe use, be sure to fix the appliance to the wall using the chain and hooked screw supplied. Ensure that the hook is screwed into the wall securely.



Gas Connection

WARNING: Before starting any work related with gas installation, turn off gas supply. Risk of explosion.

WARNING: In the UK, the Gas cooker must be installed by a registered GAS SAFE engineer. The electrical installation should be in accordance with BS 7671. Otherwise, all installations must be in accordance with the relevant instructions in this booklet, with the relevant national and local regulations, and with the local gas and electricity supply company requirements.

Natural gas connection:

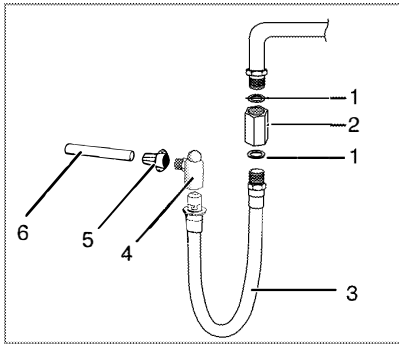

1. Gasket
2. Adapter
3. Gas (safety) hose
4. Valve with 90° outlet
5. Connection piece
6. Gas supply pipe

WARNING: The gas hose must not be clamped, bent or trapped or come into contact with hot parts of the product. There is the risk of explosion due to damaged gas hose.

Ventilation Of Room

The air needed for burning is received from room air and the gases emitted are given directly in room. For safe operation of your product, good room ventilation is a precondition. If no window or room to be utilized for room ventilation is available, additional ventilation should be installed. However, room has a door opening outside, it is no needed to vent holes.

Room Size	Ventilating Opening
Smaller than 5 m ³	min. 100 cm ²
Between 5 m ³ - 10 m ³	min. 50 cm ²
Bigger than 10 m ³	no need
In basement or cellar	min. 65 cm ²

Gas hose passage way

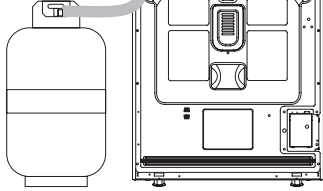

Figure 1

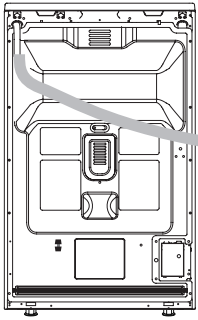

Figure 2



Connect the appliance to the gas piping tap in shortest possible route and in a way that ensure no gas leakage will occur.

In order to carry on a tightness and sealing safety check ensure that the knobs on the control panel are closed and the gas cylinder is open.

WARNING: While performing a gas leakage check, never use any kind of lighter, match, cigarette or similar burning substance.

Apply soap bubble on the connection points. If there is any kind of leakage then it will cause bubbling.

While inserting the appliance in place ensure that it is on the same level with the worktop. If required adjust the legs in order to make level with the worktop.

Use the appliance on a level surface and in a well ventilated environment.

WARNING: Before placing the appliance, check that the local distribution conditions (gas type and pressure) conform to the product settings.

Reduced gas flow rate setting for hob taps

1. Ignite the burner that is to be adjusted and turn the knob to the reduced position.
2. Remove the knob from the gas tap.
3. Use an appropriately sized screwdriver to adjust the flow rate adjustment screw. For LPG (butane-pro pane) turn the screw clockwise. For the natural gas, you should turn the screw counter-clockwise once.
“The normal length of a straight flame in the reduced position should be 6-7 mm.”
4. If the flame is higher then the desired position, turn the screw clockwise. If it is smaller turn anti clockwise.
5. For the last control, bring the burner both to high-flame and reduced positions and check whether the flame is on or off.

Depending on the type of gas tap used in your appliance the adjustment screw position may vary.

To adjust your oven acc. to the gas type, make the adjustment for reduced flame carefully by turning with a small screwdriver as shown below on the screw in the middle of the gas cocks as well as nozzle changes. (figure 3 and 4)

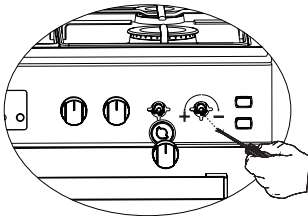

Figure 3

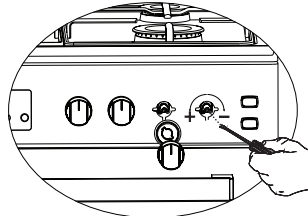

Figure 4

Nozzle change operation

1. Please use driver with special head for removed and install nozzle as.
(figure 5)

2. Please remove nozzle (figure 6) from burner with special nozzle driver and install new nozzle. (figure 7)

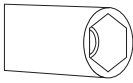

Figure 5

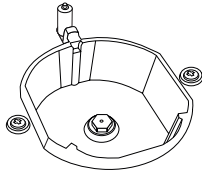

Figure 6

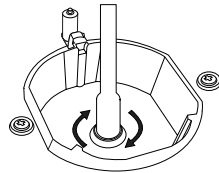

Figure 7

Removal of the upper burner:

With the help of a screw driver, remove the screw as shown in figure 11. As shown in figure 12, remove the burner from its place by pulling it to yourself. As shown in figure 13, remove the injector in the bearing with a socket wrench. In order to re-place the burner, apply the removal process reversely.

Figure 11

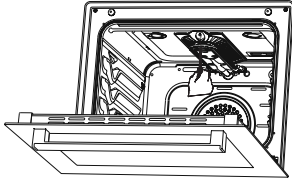

Figure 12

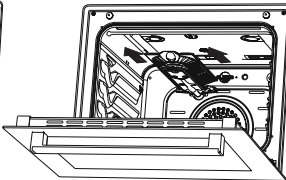
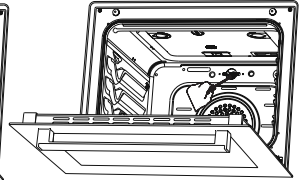

Figure 13



Removal of the Cathedral Burner

The burner protection sheet is fixed with two screws. As shown in figure 8, use a screwdriver to remove it. As shown in figure 9, press the spring clip in the direction of the arrow to remove the burner from the slot. As shown in figure 10, remove the injector in the bearing with a socket wrench. In order to re-place the burner, apply the removal process reversely.

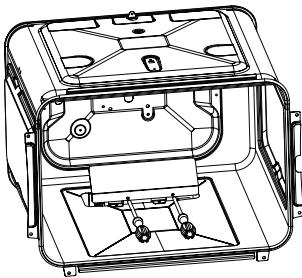

Figure 8

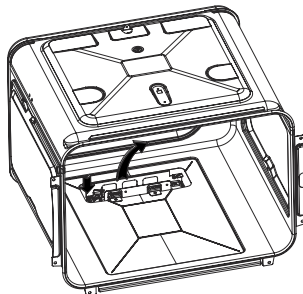

Figure 9

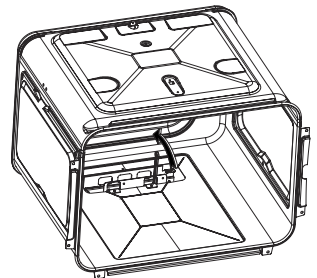
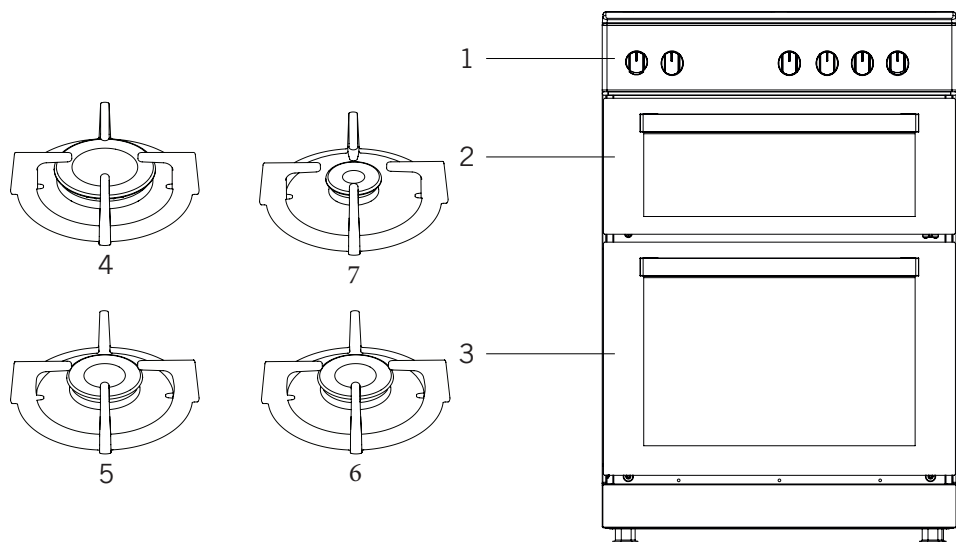

Figure 10

INTRODUCTION OF THE APPLIANCE



1. Control panel
2. Top oven
3. Main oven
4. Rapid burner
5. Semi rapid burner
6. Semi rapid burner
7. Auxiliary burner

Accessories

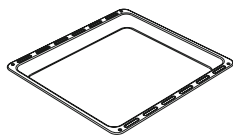

Baking tray

Used for pastry (cookie, biscuit etc.), frozen foods.

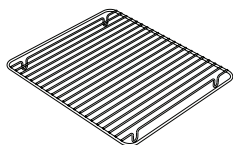

Grill tray insert

Foods to stick while cooking such as steak are placed on in tray grill. Thus contact of food with tray and sticking are prevented.

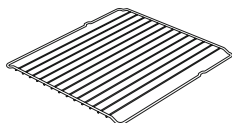

Wire grill

Used for roasting or placing foods to be baked, roasted and frozen into desired rack.

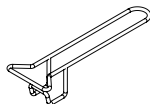

Tray handle *

It is used to hold hot trays.

Technical Features Of Your Oven

Specification		50x60	
		Main	Top
Outside width		500 mm	
Outside depth		630 mm	
Outside height		900 mm	
Lower inside width	Upper inside width	360 mm	
Lower inside depth	Upper inside depth	400 mm	
Lower inside height	Upper inside height	330 mm	180 mm
Lamp power		15-25 W	

WARNING: For the modification to be done by authorised service, this table should be considered. Manufacturer may not be held responsible for any problems rising because of any faulty modification.

WARNING: In order to increase the product quality, the technical specifications may be changed without prior notice.

WARNING: The values provided with the appliance or its accompanying documents are laboratory readings in accordance with the respective standards. These values may differ depending on the use and ambient conditions.

50x60 Double Four

Burner Specifications	G20,20 mbar G25,25 mbar			G30,28-30 mbar G31,37 mbar	
	Gas Natural			LPG	
	Wok Burner	Injector	1,40	mm	0,96
Gas flow		0,333	m ³ /h	254	g/h
Power		3,50	kW	3,50	kW
Rapid Burner	Injector	1,15	mm	0,85	mm
	Gas flow	0,276	m ³ /h	211	g/h
	Power	2,90	kW	2,90	kW
Semi-Rapid Burner	Injector	0,97	mm	0,65	mm
	Gas flow	0,162	m ³ /h	124	g/h
	Power	1,70	kW	1,70	kW
Auxiliary Burner	Injector	0,72	mm	0,50	mm
	Gas flow	0,96	m ³ /h	69	g/h
	Power	0,95	kW	0,95	kW
Grill Burner	Injector	0,92	mm	0,60	mm
	Gas flow	0,144	m ³ /h	109	g/h
	Power	1,50	kW	1,50	kW
Oven Burner	Injector	0,97	mm	0,65	mm
	Gas flow	0,171	m ³ /h	131	g/h
	Power	1,80	kW	1,80	kW

Control Panel

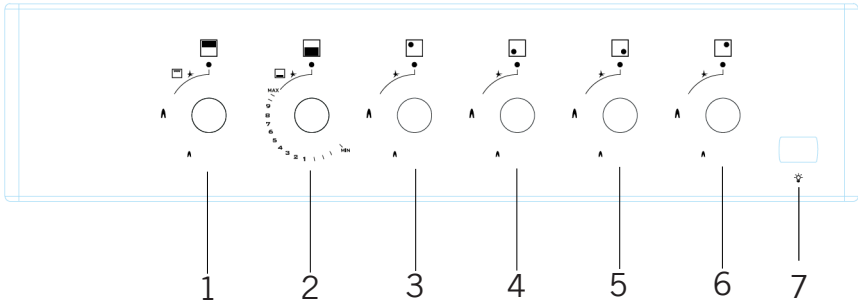

1. Top grill cavity control thermostat
2. Main oven control thermostat
3. Left rear burner
4. Left front burner
5. Right front burner
6. Right rear burner
7. Oven light

Thermostat: Used for determining the cooking temperature of the dish to be cooked in the oven. After placing the food inside the oven, turn the switch to adjust desired temperature setting between gas mark settings 1 - Max. For cooking temperatures of different food, see cooking table.

Gas	°F	°C	Fan
1	275	140	120
2	300	150	130
3	325	170	150
4	350	180	160
5	375	190	170
6	400	200	180
7	425	220	200
8	450	230	210
9	475	240	220

Gas Mark Oven Temperature Comparison



USING OVEN SECTION

Using Oven Burners

1. Your oven is equipped with burners that operate with gas, appropriate knob should be used in order to ignite the burners. Your cooker has automatic under knob ignition. To ignite the burner press and turn the knob. The burners can also be ignited by a match.
2. Do not continuously operate the igniter for more than 15 seconds. If the burner does not ignite, wait minimum one minute before trying again. If the burner is extinguished for of the any reason, close the gas control valve and wait a minimum of one minute before trying again.

Using Oven Heating Elements

1. When your oven is operated for the first time, you may smell an odour. This is normal when heating up the oven for the first time. It is recommended to operate it at Gas Mark 9 (240 °C) for 45-60 minutes before first use.
2. Oven control knob should be positioned to the desired temperature, otherwise the oven will not operate.
3. Whilst the oven is in use, the oven door should not be opened frequently to prevent the hot air escaping and therefore varying your cooking results.



Using The Grill

1. When you place the grill on the top rack, the food on the grill shall not touch the grill.
2. You can preheat for 5 minutes while grilling.
3. Food shall be in the center of the grill to provide maximum air flow through the oven.

To turn on the grill;

1. Place the function button over the grill symbol.
2. Then, set it to the desired grill temperature.

To turn the grill off;

Set the function button to the off position.

WARNING: Keep the oven door opened whilst grilling.

Using The Hob

Using gas burners

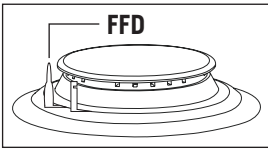

Flame cut-off safety device (FFD) , operates instantly when safety mechanism activates due to overflown liquid over upper hobs.

1. The valves controlling the gas burners have the above mentioned flame failure device. When flame of the cooker is extinguished, control valve cuts off the gas automatically. In order to light the burners, pres thw control knob inwards and rotate anti-clockwise towards the flame symbol. keep the control knob pressed in for approximately 5-10 seconds or until the flame stays lit continuously.
2. Do not continuously operate the igniter for more than 15 seconds. If the burner does not ignite, wait minimum one minute before try again.
3. If the burner is extinguished for any reason, close the gas control valve and wait a minimum of one minute before trying again.
4. ● Closed 🔥 Fully open 🔥 Half open
5. Before operating your hob please make sure that the burner caps are well positioned. The right placement of the burner caps are shown as below.

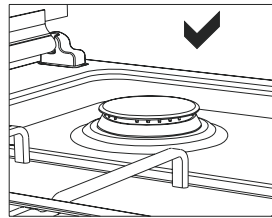
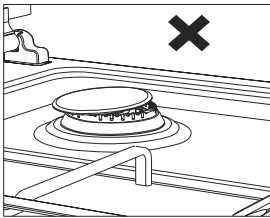

Pot Recommendation

Use flat bottomed saucepans which fully contact with the heat as much as you can, so that you can use the energy more productively.

Pot Diameter

	50*60	60*60
Aux burner	12-18 cm	12-18 cm
Semi Rapid	18-20 cm	18-20 cm
Rapid	22-26 cm	22-26 cm
WOK burner	---	24-26 cm



COOKING TIME TABLE

WARNING: Oven must be preheated for 10 minutes before placing the food in it. (Refer to Gas Mark comparison page 31)

Foods	Cooking Function	Temperature (°C)	Rack Position	Cooking Duration (min.)
Cake (Tray/Mold)	Static / Static+fan	170-180	2	35-45
Small cakes	Static / Turbo+fan	170-180	2	25-30
Patty	Static / Static+fan	180-200	2	35-45
Pastry	Static	180-190	2	25-30
Cookie	Static	170-180	3	20-25
Apple pie	Static / Turbo+fan	180-190	2	50-70
Sponge cake	Static	200/150*	2	20-25
Pizza	Static+fan	180-200	3	20-30
Lasagna	Static	180-200	2	25-40
Meringue	Static	100	2	60
Chicken	Static+fan / Turbo+fan	180-190	2	45-50
Grilled chicken	Grill	200-220	4	25-30
Grilled fish	Grill+fan	200-220	4	25-30
Sirloin steak	Grill+fan	Max.	4	15-20
Grilled meat balls	Grill	Max.	4	20-25

MAINTENANCE AND CLEANING

1. Disconnect the plug supplying electricity for the oven from the socket.
2. While oven is operating or shortly after it starts operating, it is extremely hot. You must avoid touching from heating elements.
3. Never clean the interior part, panel, trays and all other parts of the oven by the tools like hard brush, cleaning mesh or knife. Do not use abrasive, scratching agents and detergents.
4. After cleaning the interior parts of the oven with a soapy cloth, rinse it and then dry thoroughly with a soft cloth.
5. Clean the glass surfaces with special glass cleaning agents.
6. Do not clean your oven with steam cleaners.
7. Before opening the upper lid of the oven, clean spilled liquid off the lid. Also, before closing the lid, ensure that the cooker table is cooled enough.
8. Never use inflammable agents like acid, thinner and gasoline when cleaning your oven.
9. Do not wash any part of your oven in dishwasher.
10. In order to clean the front glass lid of the oven; remove the fixing screws fixing the handle by means of a screwdriver and remove the oven door. Then clean and rinse it thoroughly. After drying, place the oven glass properly and re-install the handle.

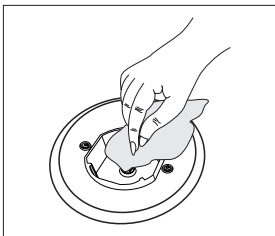

Figure 21

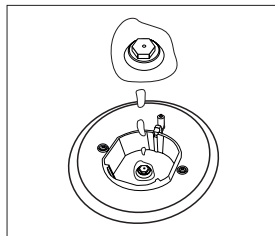

Figure 22

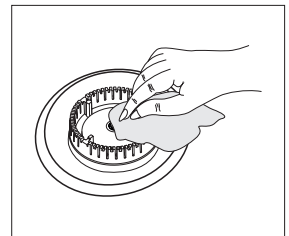

Figure 23

Cleaning And Maintenance Of The Oven's Door

Drop-down door glass

Remove the profile by pressing the plastic latches on both left and right sides as shown in figure 24 and pulling the profile towards yourself as shown in figure 25. Then remove the inner-glass as shown in figure 26. If required, middle glass can be removed in the same way. After cleaning and maintenance are done, remount the glasses and the profile in reverse order. Make sure the profile is properly seated in its place.

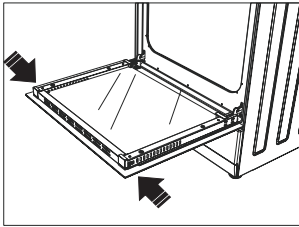

Figure 24

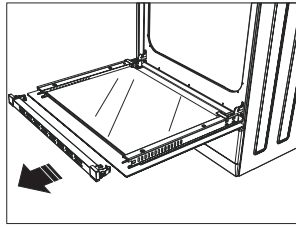

Figure 25

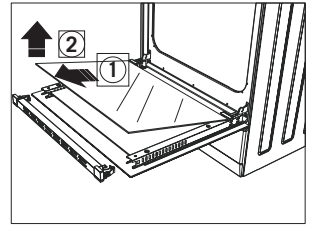

Figure 26

Side opening door glass

Open the door glass. Remove the glass by pulling upward. The outer glass is fixed to the oven door profile. After removing the glass, cleaning can be done easily. After determining procedures for cleaning and maintenance, please put the glass by pushing down. Make sure the glass is well installed.

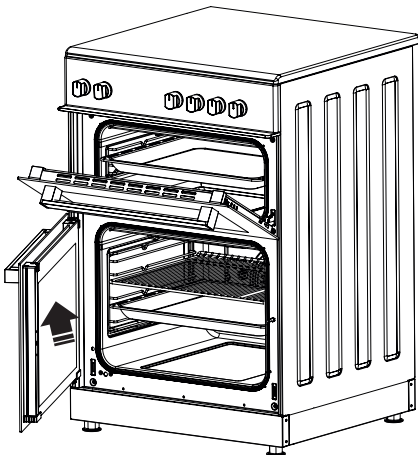

Figure 27

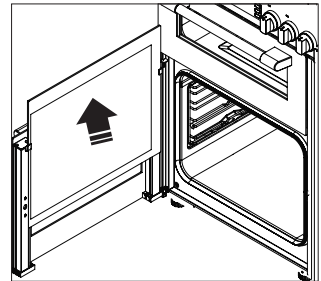
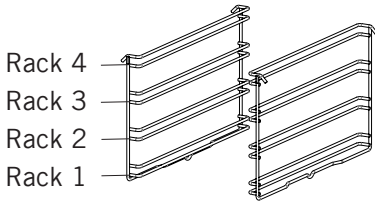

Figure 27.1

Rack Positions



It is important to place the wire grill into the oven properly. Do not allow wire rack to touch rear wall of the oven. Rack positions are shown in the next figure. You may place a deep tray or a standard tray in the lower and upper wire racks.

Installing and removing wire racks

To remove wire racks, press the clips shown with arrows in the figure, first remove the lower, and than the upper side from installation location. To install wire racks; reverse the procedure for removing wire rack.

Changing The Oven Lamp

WARNING: To avoid electric shock, ensure that the appliance circuit is open before changing the lamp. (having circuit open means power is off)

First disconnect the power of appliance and ensure that appliance is cold.

Remove the glass protection by turning as indicated in the figure. If you have difficulty in turning, then using plastic gloves will help you in turning.

Then remove the lamp by turning, install the new lamp with same specifications.

Reinstall glass protection, plug the power cable of appliance into electrical socket and complete replacement. Now you can use your oven.

Type G9 Lamp

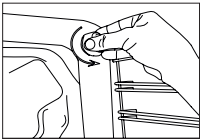

220-240 V, AC
15-25 W

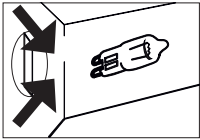
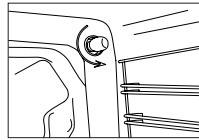

Figure 29

Type E14 Lamp



220-240 V, AC
15 W

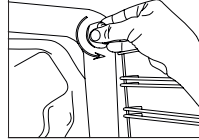

Figure 30

Using The Grill Deflector Sheet *

1. A safety panel is designed to protect control panel and the buttons when the oven is in Grill mode (figure 31)

2. Please use this safety panel in order to avoid the heat to damage control panel and the buttons when the oven is Grill mode.

WARNING: Accessible parts may be hot when the grill in use. Young children should be kept away.

3. Place the safety panel under control panel by opening the oven front cover glass (figure 32)

4. And then secure the safety panel in between oven and front cover by gently closing the cover. (figure 33)

5. It is important for cooking to keep the cover open in specified distance when cooking in grill mode.

6. Safety panel will provide an ideal cooking circumstance while protecting control panel and buttons.

WARNING: If the cooker has the “**closed grill functioned**” option with thermostat, you can keep the oven door closed during operation; in this case the grill deflector sheet will be unnecessary.

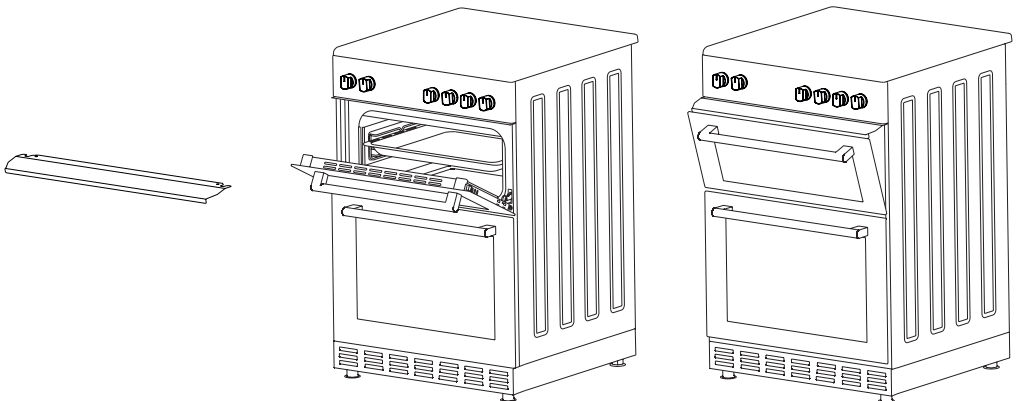

Figure 31

Figure 32

Figure 33

TROUBLESHOOTING

You may solve the problems you may encounter with your product by checking the following points before calling the technical service.

Check Points

In case you experience a problem about the oven, first check the table below and try out the suggestions.

Problem	Possible cause	What to do
Oven does not operate.	Power supply not available.	Check for power supply.
	Gas supply not available.	Check if main gas valve is open.
		Check if gas pipe is bent or kinked.
		Make sure gas hose is connected to the oven.
	Check if suitable gas valve is being used.	
Oven stops during cooking.	Plug comes out from the wall socket.	Re-install the plug into wall socket.
Turns off during cooking.	Too long continuous operation.	Let the oven cool down after long cooking cycles.
	More than one plugs in a wall socket.	Use only one plug for each wall socket.
Oven door is not opening properly.	Food residues jammed between the door and internal cavity.	Clean the oven well and try to re-open the door.
Lighter not operating.	Tips or body of ignition plugs are clogged.	Clean tips or body of ignition plugs of gas burners.
	Gas burner pipes are clogged.	Clean gas burner pipes.
Electric shock when touching the oven.	No proper grounding.	Make sure power supply is grounded properly.
	Ungrounded wall socket is used.	

Problem	Possible cause	What to do
Water dripping.	Water or steam may generate under certain conditions depending on the food being cooked. This is not a fault of the appliance.	Let the oven cool down and then wipe dry with a dishcloth.
Steam coming out from a crack on oven door.		
Water remaining inside the oven.		
Oven does not heat.	Oven door is open.	Close the door and restart.
	Oven controls not correctly adjusted.	Read the section regarding operation of the oven and reset the oven.
	Fuse tripped or circuit breaker turned off.	Replace the fuse or reset the circuit breaker. If this is repeating frequently, call an electrician.
Smoke coming out during operation.	When operating the oven for the first time.	Smoke comes out from the heaters. This is not a fault. After 2-3 cycles, there will be no more smoke.
	Food on heater.	Let the oven to cool down and clean food residues from the heater.
When operating the oven burnt or plastic odour coming out.	Plastic or other not heat resistant accessories are being used inside the oven.	At high temperatures, use suitable glassware accessories.
Oven does not cook well.	Oven door is opened frequently during cooking.	Do not open oven door frequently, if the food you are cooking does not require turning. If you open the door frequently internal temperature drops and therefore cooking result will be influenced.
Internal light is dim or does not operate.	Foreign object covering the lamp during cooking.	Clean internal surface of the oven and check again.
	Lamp might be failed.	Replace with a lamp with same specifications.



HANDLING RULES

1. Do not use the door and/or handle to carry or move the appliance.
2. Carry out the movement and transportation in the original packaging.
3. Pay maximum attention to the appliance while loading/unloading and handling.
4. Make sure that the packaging is securely closed during handling and transportation.
5. Protect from external factors (such as humidity, water, etc.) that may damage the packaging.
6. Be careful not to damage the appliance due to bumps, crashes, drops, etc. while handling and transporting and not to break or deform it during operation.

RECOMMENDATIONS FOR ENERGY SAVING

Following details will help you use your product ecologically and economically.

1. Use dark coloured and enamel containers that conduct the heat better in the oven.
2. As you cook your food, if the recipe or the user manual indicates that pre-heating is required, pre-heat the oven.
3. Do not open the oven door frequently while cooking.
4. Try not to cook multiple dishes simultaneously in the oven. You may cook at the same time by placing two cookers on the wire rack.
5. Cook multiple dishes successively. The oven will not lose heat.
6. Turn off the oven a few minutes before the expiration time of cooking. In this case, do not open the oven door.
7. Defrost the frozen food before cooking.

Help and assistance

If you require any technical guidance or find that your Freestanding Cooker is not operating as intended, a simple solution can often be found in the Troubleshooting section of these instructions or online at www.newworldassist.co.uk

If you still require further assistance, call one of our experts on 0333 3052263. To help give us give you a fast and efficient service please have the following information ready:

Model Ref.

Serial number

Date of purchase

Declaration of conformance to product standards

This appliance conforms to all relevant standards applicable to domestic appliances sold in the UK

Disposal



This appliance/fitting is marked according to the European directive 2012/19/EU on Waste Electrical and Electronic Equipment (WEEE).

By ensuring this product is disposed of correctly, you will help prevent potential negative consequences for the environment and human health, which could otherwise be caused by inappropriate waste handling of this product.

The symbol on the product, or on the documents accompanying the product, the **crossed out wheellie bin** symbol, indicates that this appliance/fitting may not be treated as household waste. Instead it shall be handed over to the applicable collection point for the recycling of electrical and electronic equipment.

Disposal must be carried out in accordance with local environmental regulations for waste disposal.

For more detailed information about treatment, recovery and recycling of this product, please contact your local authority, your household waste disposal service or the retailer where you purchased the product.

Activate your 24 month guarantee

Thank you for choosing New World. Your new product is guaranteed against faults and breakdowns for 24 months. Don't forget to register it with us today so we can provide you with our best possible after-sales service and useful updates on

www.newworldassist.co.uk

Or call **0333 3052263** for your New World Guarantee.

This product is guaranteed for twenty four months from the date of original purchase. Any defect that arises due to faulty materials or workmanship will be repaired free of charge (or if applicable the product will be replaced or the purchase price refunded) where possible during this period by the dealer from who your purchased the unit.

- The guarantee does not cover accidental damage, misuse, cabinet parts, knobs or consumable items.
 - The product must be correctly installed and operated in accordance with the instructions contained in the manual.
 - It must be used solely for domestic purposes. The guarantee will be rendered invalid if the product is re-sold or has been damaged by inexperienced repair.
- Specifications are subject to change without notice.
- New World disclaim any liability for loss or damage arising from the breakdown of the product.
 - This guarantee is in addition to and does not diminish your statutory or legal rights.

Important Data Protection Information

To find out how we use your data please refer to the guarantee registration material or visit www.newworldassist.co.uk