

**|||||**  
**newWORLD®**  
TUMBLE DRYER

**Capacity: 7.0kg**

**Model: NW7KGVTDW  
NW7KGVTDDB**

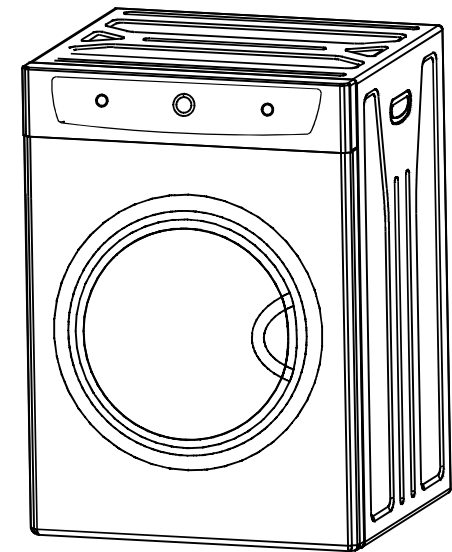

**Instruction Manual**

**Customer service Helpline: 0333 305 2263**

**|||||**  
**newWORLD®**  
made for your world

## ***Welcome***

Dear users, this manual contains the product's basic knowledge, how to use it, fault diagnosis and basic troubleshooting methods. In order to better understand and use this product, please take good care of this manual and read it carefully.

## ***Help and Guidance***

We're here to help you get most from your Tumble dryer. Should you require any guidance, a simple solution can often be found online at:

[www.newworldassist.co.uk](http://www.newworldassist.co.uk)

if you still require further assistance, call one of our experts on 0333 3052263.

if you require any technical guidance or find that your product is not operating as intended, a simple solution can often be found in the Troubleshooting section of these instructions, or online at [www.newworldassist.co.uk](http://www.newworldassist.co.uk) if you still require further assistance, call one of our experts on 0333 3052263.

## Guarantee

### Activate your 24 month guarantee

Thank you for choosing New World. Your new product is guaranteed against faults and breakdowns for 24 months. Don't forget to register it with us today so we can provide you with our best possible after-sales service and useful updates.

[www.newworldassist.co.uk](http://www.newworldassist.co.uk)

Or call 0333 3052263

### Your New World Guarantee

This product is guaranteed for 24 months from the date of original purchase. Any defect that arises due to faulty materials or workmanship will be repaired free of charge (or if applicable the product will be replaced or the purchase price refunded) where possible during this period by the dealer from whom you purchased the unit.

The guarantee is subject to the following provisions:

- The guarantee does not cover accidental damage, misuse, cabinet parts, knobs or consumable items.
- The product must be correctly installed and operated in accordance with the instructions contained in the manual.
- It must be used solely for domestic purposes. The guarantee will be rendered invalid if the product is re-sold or has been damaged by inexpert repair.
- Specifications are subject to change without notice.
- New World disclaim any liability for loss or damage arising from the breakdown of the product.
- This guarantee is in addition to and does not diminish your statutory or legal rights.

### Important Data Protection Information

To find out how we use your data please refer to the guarantee registration material or visit [www.newworldassist.co.uk](http://www.newworldassist.co.uk)

## Important Safeguards

**When using electrical appliances, in order to reduce the risk of fire, electric shock, and/or injury to persons, basic safety precautions should always be followed, including:**

### For Your Safety

**Read all instructions carefully, even if you are quite familiar with the appliance.**

- This appliance is not intended for use by persons (including children) with reduced physical, sensory or mental capabilities, or lack of experience and knowledge, unless they have been given supervision or instruction concerning use of the appliance by a person responsible for their safety.
- Young children should be supervised to ensure that they do not play with the appliance.
- INDOOR USE ONLY this appliance is not intended for outdoor use.
- Do not place naked flame sources, such as candles, on the appliance.
- Do not locate the appliance or cord near heat sources such as radiators, heaters, air ducts or direct sunlight.
- Do not block any of the ventilation openings. Ensure that vents are not covered by newspapers, tablecloths, curtains, etc.
- Do not run the cord under floor coverings. Instead, arrange the cord away from traffic areas where it will not become a trip hazard.
- To disconnect the appliance, turn the appliance off, switch off the power outlet and remove the plug from the power outlet.
- Do not misuse the cord. Never carry the appliance by the cord or pull to disconnect it from the outlet. Instead, grasp the plug and pull to disconnect.
- Do not operate the appliance if it has a damaged cord or plug; after the appliance malfunctions; or has been dropped or damaged in any way. Consult the manufacturer.
- Do not attempt to repair, disassemble or modify this appliance. The warranty becomes void if not serviced or repaired by a Qualified person.
- Do not place items that have been soiled with flammable liquids inside the dryer without washing them with detergent thoroughly before hand.
- Do not excessively bend, stretch, twist or bind the power cord or place heavy objects on it.
- This appliance is only to be serviced by a qualified person. There are no user-serviceable parts inside.
- Do not use an extension cord with this appliance.
- Do not install in a tight fitting cabinet.
- Do not overload the laundry dryer.
- Ensure foreign objects do not find their way into the tub of the laundry dryer.
- The door window may be hot after a long drying cycle. Please ensure children are kept away from the machine.
- If the laundry dryer is not wall mounted, place in a flat, firm, dry and drafty place. Use the adjustable front legs to assist in leveling the dryer if need be. Do not place it on any soft material such as foam or plastic
- Do not use flammable or combustible materials such as gas, petrol, alcohol or lacquer in the laundry dryer.
- After turning off the power supply to the laundry dryer, wait at least 2 minutes before turning it back on again.
- Please remove the transport packaging at the rear of the laundry dryer, prior to use.
- If the supply cord is damaged, it must be replaced by the manufacturer, its service agent or similarly qualified persons in order to avoid a hazard.

**CAUTION:** If this appliance is supplied from a cord extension set or an electrical portable outlet device, the cord extension set or electrical portable outlet device must be positioned so that it is not subject to splashing or ingress of moisture.



**Oil-affected items can ignite spontaneously, especially when exposed to heat sources such as in a laundry dryer. The items become warm, causing an oxidation reaction in the oil. Oxidation creates heat. If the heat cannot escape, the items can become hot enough to catch fire. Piling, stacking or storing oil-affected items can prevent heat from escaping and so create a fire hazard.**

- If it is unavoidable that fabrics that contain vegetable or cooking oil or have been contaminated contaminated by hair care products be placed in a laundry dryer they should first be washed in hot water with extra detergent-this will reduce, but not eliminate, the hazard.
- Do not dry unwashed items in the laundry dryer.
- Items that have been soiled with substances such as cooking oil, acetone, alcohol, petrol, kerosene, spot removers, turpentine, waxes and wax removers should be washed in hot water with an extra amount of detergent before being dried in the laundry dryer.
- Items such as foam rubber (latex foam), shower caps, waterproof textiles, rubber backed articles and clothes or pillows fitted with foam rubber pads should not be dried in the laundry dryer.
- Fabric softeners, or similar products, should be used as specified by the fabric softener instructions.
- The final part of a laundry dryer cycle occurs without heat (cool down cycle) to ensure that the items are left at a temperature that ensures that the items will not be damaged.
- Remove all objects from pockets such as lighters and matches.

**WARNING:** Never stop a laundry dryer before the end of the drying cycle unless all items are quickly removed and spread out so that heat is dissipate.

- The maximum mass of dry textile material in kilograms to be used in the appliance;
- That the laundry dryer is not to be used if industrial chemicals have been used for cleaning;
- That the lint trap has to be cleaned frequently, if applicable;
- That lint must not be allowed to accumulate around the laundry dryer (not applicable for appliances intended to be vented to the exterior of the building);
- That adequate ventilation has to be provided to avoid the back flow of gases into the room from appliances burning other fuels, including open fires.

**NOTE** This instruction is not required if the laundry dryer discharges the air into the room.

- For appliances with ventilation openings in the base, that a carpet must not obstruct the openings;
- That exhaust air must not be discharged into a flue which is used for exhausting fumes from appliances burning gas or other fuels.

**NOTE** This instruction is not required if the laundry dryer discharges the air into the room.

- That the appliance must not be installed behind a lockable door, a sliding door or a door with a hinge on the opposite side to that of the laundry dryer, in such a way that a full opening of the laundry dryer door is restricted.

*Save These Instructions*

## **Product Support**

### **Declaration of conformance to product standards**

This appliance conforms to all relevant standards applicable to domestic appliances sold in the UK

### **Disposal**



This appliance/fitting is marked A according to the European directive 2012/19/EU on Waste Electrical-and Electronic Equipment(WEEE). By ensuring this product is disposed of correctly, you will help prevent potential negative consequences for the environment and human health, which could otherwise be caused by inappropriate waste handling of this product.

The symbol on the product, or on the documents accompanying the product, the crossed out wheeled bin symbol, indicates that this appliance/fitting may not be treated as household waste. Instead it shall be handed over to the applicable collection point for the recycling of electrical and electronic equipment. Disposal must be carried out in accordance with local environmental regulations for waste disposal.

For more detailed information about treatment, recovery and recycling of this product, please contact your local authority, your household waste disposal service or the retailer where you purchased the product.

## Troubleshooting

Review the following pages before calling for service.

Problem	Possible Cause	What to do
Timer knob does not turn	<ul style="list-style-type: none"> <li>Is the power cord inserted firmly?</li> </ul>	<ul style="list-style-type: none"> <li>Insert the power cord firmly.</li> </ul>
Drum does not turn	<ul style="list-style-type: none"> <li>Is the door closed?</li> <li>Is the power cord inserted?</li> <li>Does the receptacle have power?</li> </ul>	<ul style="list-style-type: none"> <li>Close the door.</li> <li>Insert the power cord firmly.</li> <li>Check the power cord receptacle.</li> </ul>
Hot air is not blowing out	<ul style="list-style-type: none"> <li>Does the receptacle have power?</li> </ul>	<ul style="list-style-type: none"> <li>Set the timer to hot air.</li> </ul>
The laundry is not thoroughly dried	<ul style="list-style-type: none"> <li>Are the front and back filters clogged?</li> <li>Is there too much laundry in the dryer?</li> <li>Have items been added whilst the dryer is in operation?</li> <li>Has the laundry become twisted whilst drying?</li> <li>Has the dryer been placed in a small and badly ventilated area?</li> <li>Have you set the dryer to Anti-Wrinkle?</li> </ul>	<ul style="list-style-type: none"> <li>Clean the filter,</li> <li>Reduce the amount in the dryer.</li> <li>Re-dry the items again.</li> <li>Untwist the items and re-dry.</li> <li>Place the dryer in a well-vented area.</li> <li>Try using 'Warm' or 'Hot' setting instead.</li> </ul>
Dryer does not start	<ul style="list-style-type: none"> <li>Is there a power failure?</li> <li>Is the power cord inserted firmly?</li> <li>Is the door closed?</li> <li>Is the timer in the OFF position?</li> </ul>	<ul style="list-style-type: none"> <li>Try again when there is power.</li> <li>Insert the power cord firmly.</li> <li>Close the door.</li> <li>Set the dry time.</li> </ul>

## Dryer Technical Specifications

Model	NW7KGVTDW/NW7KGVTDDB
Drying Capacity	7.0 kg
Power Source	220-240V~50/60Hz
Rated Input	1800 W
Net Weight	27.5kg
Dimensions	600x565x850mm

**NOTE: Consistent with our continuing product development policy, improvements may have been made which render the contents of this package slightly different to that shown.**

**Customer service Helpline: 0333 305 2263**

## Name of the Components

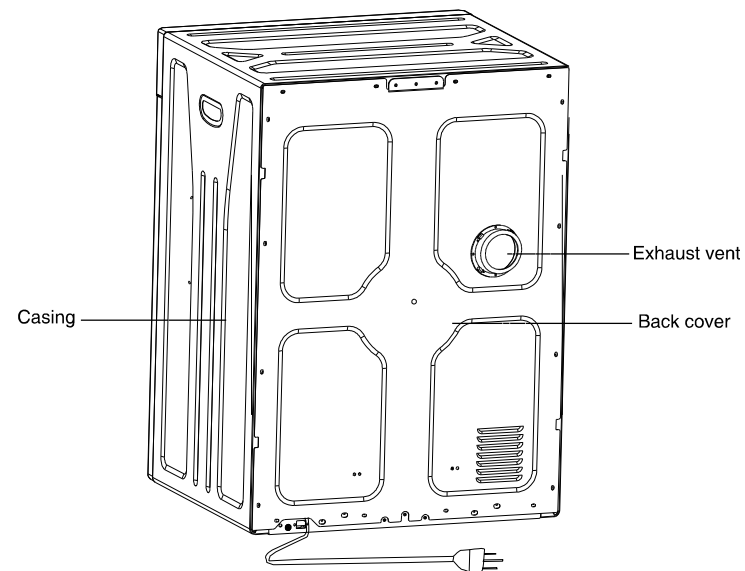
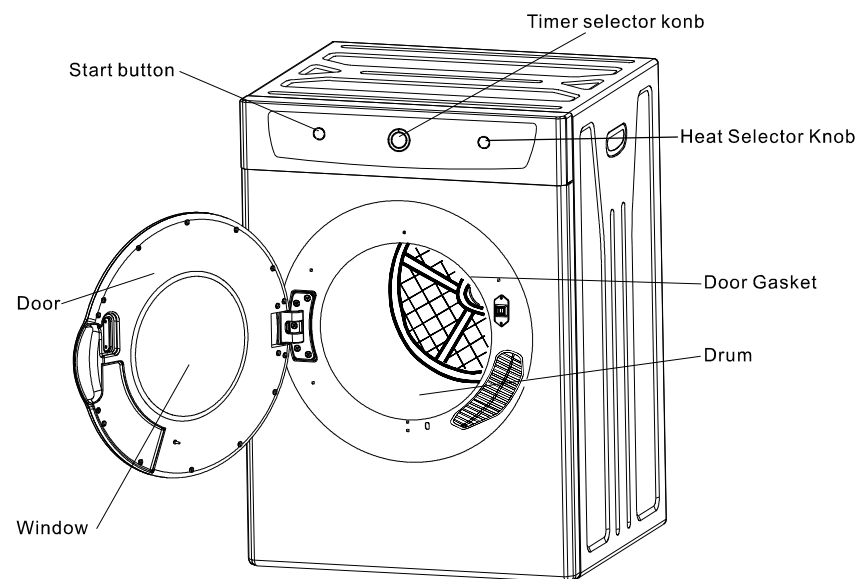

## Operating your dryer

### Electrical Requirements

The unit is required to be plugged into a three pin socket that is reliably grounded. Plug the power cord into the socket.

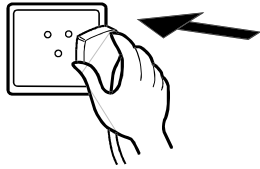

### Loading the dryer

It is recommended that items are placed into the dryer one at a time. This ensures they are not tangled which results in uneven drying. When closing the dryer door prior to starting the unit ensures that items are not jammed in the door.

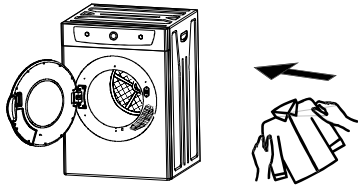

### Tips before drying

Prior to loading the dryer check that the items do not have the following symbols anywhere on them. If they do, do not laundry dry these items.

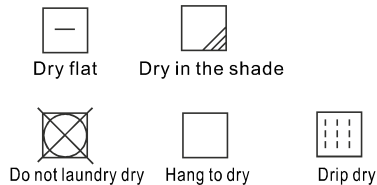

- Check the items to be dried do not have combustible materials or foreign objects within them i.e.: lighters, hair pins, coins.

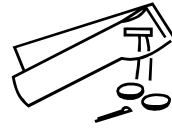

- Turn items with zippers inside out and fasten buckles.



- Dryer heat may permanently set stains, ensure you check prior to drying that stains are removed
- Separate dark and light colored items as you would do when washing.
- For best results load the dryer with similar fabrics. Place small delicate items in a mesh bag and do not overload the dryer.
- The maximum mass is 7.0 kilogram's of dry textile material for the dryer and do not overload. The laundry dryer is intended only for drying textile material washed in water.

### Drying time reference table

Drying Capacity	Dry time	
	High	Low
Approx.2kg	Approx.30min	Approx.55min
Approx.3kg	Approx.60min	Approx.110min
Approx.5kg	Approx.120min	Approx.200min
Approx.7kg	Approx.200min	—

Drying times can be affected by many factors, such as material, bulkiness, how full the dryer is etc. The above list is only a guide only.

## Maintenance

### Cleaning the Lint Filter

Please unplug the power cord prior to any cleaning. The lint filter must be in place whenever drying. It must be cleaned before each use.

#### 1. Removing the filters

Remove by pulling outwards with fingers, inserted into the four holes around the exhaust vent shroud. The filter is in 3 parts: Exhaust vent shroud, lint filter and exhaust filter (as shown in figure 1)

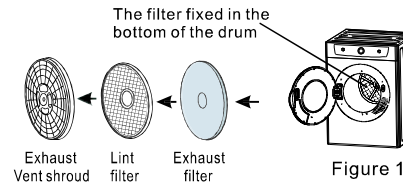

#### 2. Cleaning the filter

Separate "exhaust vent shroud", "lint filter" and "exhaust filter". Clean the lint on the lint filter and exhaust filter with a soft brush or vacuum cleaner. Do not damage the filters(as show in figure 2).

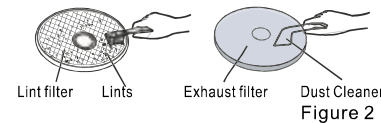

#### 3. Re-installing the filter

After cleaning, assemble in the sequence of "exhaust filter - lint filter- exhaust vent shroud", align the recesses in the center with the projection in the center of the drum. Make sure that it is firmly inserted (as shown in figure 3).

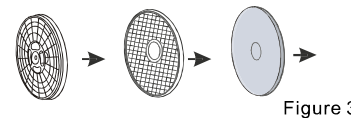

**Note: The filter fixed in the bottom of the drum should also be cleaned with a soft brush.**

### Cleaning of the Air Intake Filter

The filter should be cleaned once a month.

Remove by pulling outwards holding the upper and lower ends of the air intake shroud. Remove the filter inside the shroud and clean it with a soft brush. Reassemble and install as before.

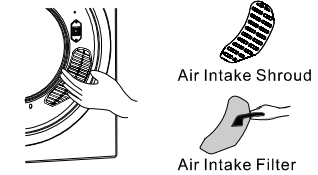

Slightly push upwards with your thumb until the latch hook disconnects, then remove.

### Cleaning the interior & exterior of the Dryer

Do not wash directly with water.

Do not use thinner, gasolene or alcohol.

Do not use any type of spray cleaner when cleaning the interior. If dryer drum becomes stained, clean the drum with a damp cloth.

Remove any residue before drying the next load.

Clean cabinet with mild soap and water. Do not use harsh or abrasive cleaners, this could damage the dryer.

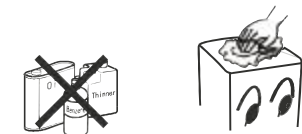

## WARNING: Regularly clean the lint trap

**CAUTION! HOT SURFACE**

- Do not touch the intake during the drying cycle due to high temperatures

**READ THE INSTRUCTIONS**

## Installation Instructions

### This dryer can not be used upside down Where to place your dryer?

Place the dryer in a dry well ventilated area. It should be positioned away from heat and direct sunlight.

If the dryer is not wall mounted, it must be placed on firm horizontal ground. Do not place the dryer on carpet as this will block the intake. There should be at least 15cm between the dryer and the walls.

The dryer comes with fixed legs that need to be assembled to ensure stability.

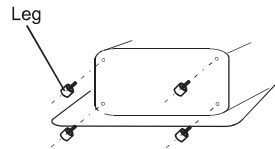

If the dryer is rack mounted. A secure bracket is required to ensure stability and prevent vibration. At least 15cm between the dryer and walls is required (The bracket is not included).

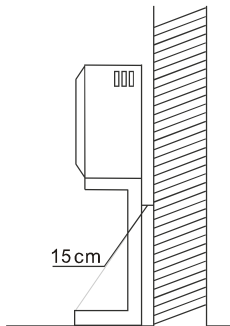

Bracket

## Wall Mounting Instructions

1. Determine dryer position on wall and mark required bracket position. This dryer is not suitable to be directly placed on top of a washing machine.

\* A minimum 50mm is needed between the top of the dryer and the ceiling for ease of installation.

\* If mounting above a washing machine, allow sufficient room to open the lid of the washer.

Tools required			
Tools & parts required for Plaster/ wooden wall	Drill & 3mm Bit	1	
	Phillips Head Screw Driver	1	
	Wood Screws, $\phi 12 \times 50$ mm Timber Screws	4	
	Helper to lift dryer onto wall	1	
Wall Mounting Kit Includes			
Description	Exhaust connector		1

2. Install the Exhaust Connector. Adjust the direction to suit the installation (as per Fig. 2).
3. Rotate the Connector clockwise to fix the pipe to the Connector Base. Tighten.

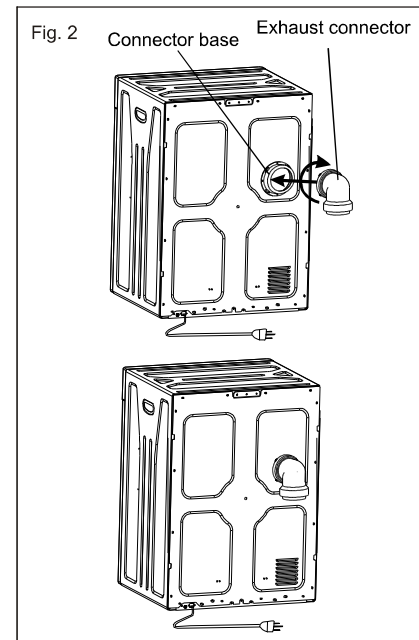

## Control Panel Functions

### Heat Selector button

Select 'High Dry' for items that are particularly bulky or large quantities. Select 'Low Dry' for delicate items such as silk, nylon, linen etc.

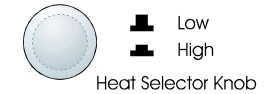

### Drying Program Selector

There are five drying combinations available: Cool, Anti-wrinkle, Warm, Hot and Air dry.

**Air Dry:** This function runs with cool air, primarily to air items that require freshening. i.e.: clothes that have been stored for a long period of time.

**Off:** When the 'Drying Timer' dial is in the 'Off' position no power is supplied to the unit. As soon as the dial is turned clockwise to the desired program, the dryer will start.

**Cool:** This function is generally used to cool the items that have just been dried. This helps to prevent creasing. Instead of the motor pushing heat into the drum of the dryer it will generate cool air.

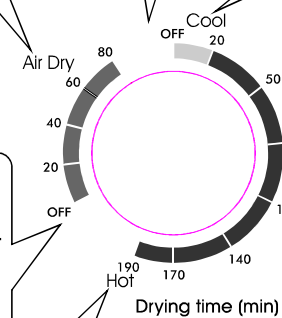

**Off:** When the 'Drying Timer' dial is in the 'Off' position no power is supplied to the unit. As soon as the dial is turned clockwise to the desired program, the dryer will start.

**Warm:** Anti-wrinkle function: This is used for items that are difficult to iron i.e.: cotton shirts and linen. Using the heat selector knob choose 'Low'. Set the drying timer knob between 30 – 60 minutes depending on the amount of items in the dryer. Once the timer stops (including the Cool program) the items will still contain moisture, making the ironing process easier.  
**Warm drying function:** This function will dry and cool items and in most cases leave items wrinkle free (depending on material). Select the 'High' heat option. Set the timer between 60-120 minutes.

**Hot:** For drying large quantities or bulky items (Dryer drum is more than 1/2 full). Select the 'High' heat option and set the timer for more than 120 minutes.

### Start button

After having set up the Heat Selector and Timer Dial, press the Start button. the dryer will start and work until the program is finished. If the during this process the door is opened or power is switched off, the dryer will stop working. In order to start the dryer again after the door is closed or power is switched back on, you will need to push the Start button, then the dryer will start working again.



**NOTE:** This Start button is only designed to start the dryer working. If you press this button during the drying process, the dryer will not pause. In order to stop the dryer, you must turn the timer dial to the Off position.

## Operation Precautions

Delicate items should be placed into a nylon net bag prior to drying. It is not recommended to dry under wire bras in this unit.

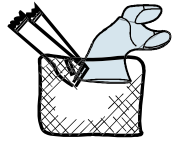

Ensure that foreign objects do not find their way into the dryer. All pockets should be emptied, buttons, buckles and zips fastened. This will also help reduce impact noise when the items hit against the turning drum.

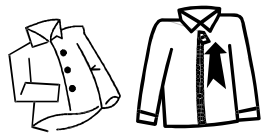

Do not add items into the dryer whilst it is in operation.

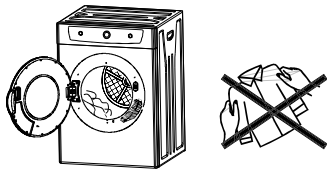

If drying large items such as a blanket, it is recommended that from time to time you open the dryer door, shake the item, place the item back in the dryer and close the door. This will ensure even drying.

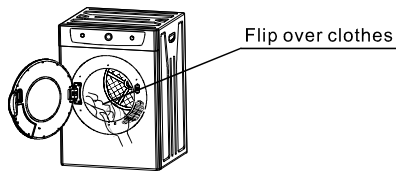

To ensure you get the most out of the Anti-wrinkle function do not overload the dryer and remove the dried items from the dryer immediately and hang on coat hangers. Iron the items if desired.

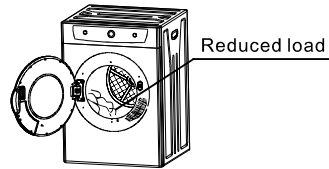

To minimize the risk of fire in a laundry dryer, the following should be observed:

- Items that have been spotted or soaked with vegetable or cooking oil constitute a fire hazard and should not be placed in a laundry dryer.

Oil-affected items can ignite spontaneously, especially when exposed to heat sources such as in a laundry dryer. The items become warm, causing an oxidation reaction in the oil. Oxidation creates heat. If the heat cannot escape, the items can become hot enough to catch fire. Piling, stacking or storing oil-affected items can prevent heat from escaping and so create a fire hazard.

If it is unavoidable that fabrics that contain vegetable or cooking oil or have been contaminated by hair care products be placed in a laundry dryer they should first be washed in hot water with extra detergent this will reduce, but not eliminate, the hazard.

The 'cool down' cycle of laundry dryers should be used to reduce the temperature of the items. They should not be removed from the laundry dryer or piled or slacked while hot.

Items that have been previously cleaned in, washed in, soaked in or spotted with petrol/gasoline, dry-cleaning solvents or other flammable or explosive substances should not be placed in a laundry dryer.

Highly flammable substances commonly used in domestic environments include acetone, denatured alcohol, petrol/gasoline, kerosene, spot removers (some brands), turpentine, waxes and wax removers.

- Items containing foam rubber (also known as latex foam) or similarly textured rubber, like materials should not be dried in a laundry dryer on a heat setting.

Foam rubber materials can, when heated, produce fire by spontaneous combustion.

- Fabric softeners or similar products should not be used in a laundry dryer to eliminate the effects of static electricity unless this practice is specifically recommended by the manufacturer of the fabric softener or product.
- Undergarments that contain metal reinforcements should not be placed in a laundry dryer.

Damage to the laundry dryer can result if metal reinforcements come loose during drying. When available a drying rack could be used for such items.

- Plastic articles such as shower caps or babies' waterproof napkin covers should not be placed in a laundry dryer.
- Rubber-backed articles, clothes fitted with foam rubber pads, pillows, galoshes and rubber-coated tennis shoes should not be placed in a laundry dryer.